



# INSET GAS FIRES

Classic Fireplaces • Fire Baskets

# Relax - it's a Gazco Fire

## A warm welcome

Designed to warm the very heart of your home, a Gazco Inset Gas Fire brings you the promise of cosy comfort throughout those long winter nights; even if you don't have a chimney!

Whether you want to achieve an up-to-the-minute, contemporary look or have your heart set on a more traditionally-designed fire, you will find a choice of highly-realistic flame effects and elegant frame options to suit your decorative style and budget.

Each model has been specially developed with ease of installation in mind, giving you excellent value for money through reduced fitting costs – and in most cases, you do not have to have a wall or floor vent installed either. For more information, or to view our complete range of Gas & Electric fires and stoves, simply visit [www.gazco.com](http://www.gazco.com).

## Gazco Retailer Network

We take great care to ensure that our fires are designed, tested and manufactured to the highest possible quality and safety standards. We are just as concerned to make certain that they are sold and installed correctly so that you enjoy years of pleasure from your fire.

Accordingly, you will find our products are only available from experienced, independent retailers who will be happy to show you a selection of models locally in their showrooms, often fully operational. These independent retailers will discuss your individual requirements both technical (such as sizing the heat output to your room and advising on your flue type) and design, and ensure that you select the most appropriate product for your home.

They will also be able to advise on, or assist with, the installation process as well as help provide any after-sales support and servicing your appliance may require in the future.

Whilst we encourage our retailers to promote fireplace products and their outlets via the internet, we do not believe suitable levels of customer care and satisfaction can be obtained from purchasing online and we would strongly recommend that you consider this when undertaking your research and making a purchasing decision. Furthermore, please be aware that we do not offer technical support (beyond our statutory responsibilities) to products bought via nationwide online sales, where this support would normally be offered by one of our qualified, independent retailers.

Furthermore, Gazco fires purchased from within our Expert Retailer Network will have the additional benefit of a greatly extended warranty period, subject to terms and conditions. Full details can be found at [www.gazco.com](http://www.gazco.com).

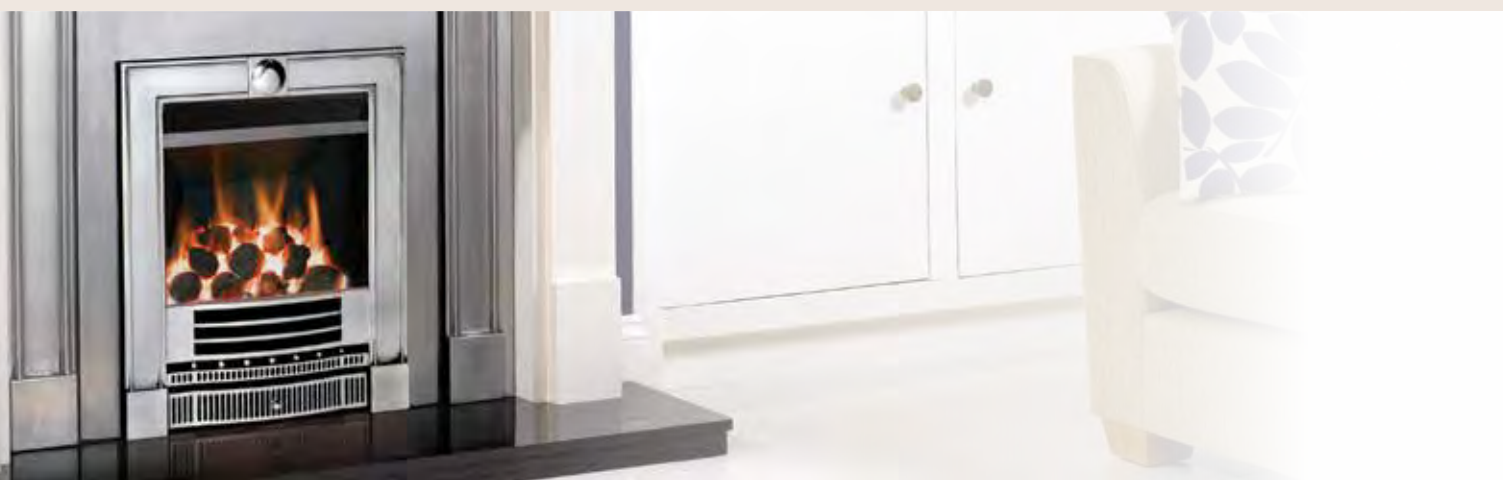



## The Gazco pedigree

When you choose a Gazco Inset Fire, quality and technology are assured. Gazco's UK research and development laboratories are not only amongst the most advanced in the world but the company is also ISO9001 accredited.

This means there is a rigorous quality control system to ensure that all our appliances comply with British safety standards as well as stringent European regulations. All fires in this brochure are CE marked. This means they have been independently tested to exacting European standards for safety as well as both heating efficiency and emissions.



With over 25 years of proven experience of manufacturing quality Gas fires at Gazco, you can be confident that when you select a Gazco fire, quality and reliability are assured.

## Warranty

Your Gazco Expert Retailer will provide you with a Five Year Extended Warranty for your new gas fire, provided your fire is registered with Gazco. Please note, these warranties exclude certain consumable parts. Fires purchased outside of Gazco's Expert Retailer Network will carry a standard 1 Year Warranty. Full warranty terms and conditions are available to view at [www.gazco.com](http://www.gazco.com).



## Contents

<b>The right fire for your home</b>	4
<b>Logic™ Fires</b>	6
Logic™ Control Options	8
Logic™ Hotbox	10
Logic™ Convector	14
Logic™ HE	18
Logic™ Front & Frame choices	22
<b>E-Box™ &amp; E-Studio™ Fires</b>	26
E-Box™	28
E-Studio™	32
E-Box™ & E-Studio™ Front & Frame choices	36
<b>Riva2 500 Fires</b>	40
<b>VFC Fires</b>	46
VFC Convector	48
VFC Tapered	50
VFC Front & Frame choices	52
<b>Classic Fireplaces</b>	54
<b>Fire Baskets</b>	60
<b>Made To Measure Fires</b>	68
<b>Technical Information</b>	70
<b>Important Information</b>	81







# The right fire for your home...



The table opposite has been designed to assist you in choosing the right fire for your home. Gazco's different inset fire options allow you to mix and match a wide selection of traditional and contemporary frames, fronts and fires so you can create the perfect welcoming centrepiece for your home.



Logic™ Fires			E-Box™ & E-Studio™ Fires		Riva2 500 Fires	VFC Fires	
Pages 6 - 25			Pages 26 - 39		Pages 40 - 45	Pages 46 - 53	
							
Logic™ Hotbox	Logic™ Convector	Logic™ HE	E-Box™	E-Studio™	Riva2 500	VFC Convector	VFC Tapered



### Choice of Operation:

Manual versions	✓	✓	✓	✓	✓	✗	✓	✓
Slide control	✓	✓	✓	✗	✗	✗	✗	✗
Remote control	✓	✓	✓	✓	✓	✓	✓	✓

### Choice of Fuel Bed:

Coal	✓	✓	✓	✓	✗	✗	✓	✓
Pebble	✓	✓	✗	✓	✗	✗	✗	✗
White Stone	✗	✗	✓	✗	✓	✗	✗	✗
Logs	✗	✗	✗	✗	✗	✓	✗	✗

### Key Features:

Convected heat	✗	✓	✓	✓	✓	✓	✓	✗
Radiant heat	✓	✓	✓	✓	✓	✓	✓	✓
Wide selection of frames	✓	✓	✓	✓	✓	✓	✓	✗
Natural Gas or LPG	✓	✓	✓	✓	✓	✓	✓	✓
Can be wall mounted	✗	✗	✓	✓	✓	✓	✗	✗
Variable flame colour	✗	✗	✗	✗	✗	✗	✓	✓
Ambient open fire	✓	✓	✗	✗	✗	✗	✓	✓
Glass fronted high efficiency	✗	✗	✓	✓	✓	✓	✗	✗
ODS safety feature*	✓	✓	✓	✓	✓	✓	✓	✓
Additional air vent required	✗	✗	✗	✗	✗	✗	✗◇	✗◇
Conventional Flue 	✓	✓	✓	✓	✓	✓	✓	✓
Balanced Flue 	✗	✗	✓	✓	✓	✓	✗	✗
Maximum Efficiency 	60%	68.5%	89%	86%	82%	82%	50%	25%

(See page 71 to identify your chimney type - more detailed chimney information can also be found on the individual product pages)

### Classic Fireplaces

Pages 54 - 59



### Fire Baskets

Pages 60 - 67



### Made-To-Measure Fires

Pages 68 - 69



\* ODS (Oxygen Depletion Sensor) - This safety feature will shut off the gas supply to the burner in the event of a reduction to oxygen levels in the room (conventional flue only).  
◇ 16" RD VFC models only. Standard 16" & 22" models will require an air vent.

# Logic™ Fires

There are three different fires in the Logic family to choose from: the Logic Hotbox, Logic Convector or the Logic HE. As well as benefitting from lower installation costs by choosing a Logic fire, additional savings can be made as these are all Reduced Draught fires, meaning that in most cases a wall or floor vent is not required. The Logic range is offered with a wide selection of frames and finishes; the full selection can be seen on pages 22-25.



# Logic™ Hotbox



Suitable for all chimney types, the Logic Hotbox is an open-fronted fire that provides a warm focal point without the additional heat emitted by the Logic Convector or Logic HE. This fire offers you the options of either coal or pebble fuel beds (1) and the choice of a manual or remote control version.

The Hotbox draws cool room air into the bottom of the appliance (2) and then emits radiant heat into the room (3) via the glow generated on the ceramic fuel bed. This provides convenient and comforting warmth whilst retaining all the ambience of a real open fire.

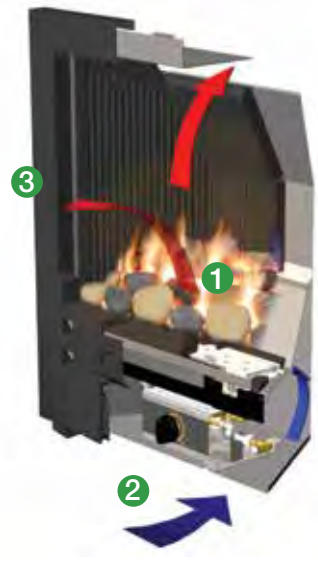

# Logic™ Convector



The Logic Convector is a highly efficient open fire suitable for all chimney types. It incorporates a convection system that provides additional heat and efficiency to that of the Hotbox. Available with coal or pebble fuel beds (1) and the option of either manual or remote control versions.

The convector box draws cool room air into the bottom of the convection chamber (2) the cool air is warmed as it passes over the hot surfaces of the chamber (3) and the hot air is then emitted back into the room via the top convection slot (4).

# Logic™ HE



The latest in the Logic range, the Logic HE has a glass front and boasts the highest efficiency of all the Logic Fires at up to 89%. The HE is manually operated with a choice of either coal or white stone fuel effects (1). With both conventional and balanced flue models, the HE is even suitable for homes without a chimney!\*

The Logic HE box draws cool room air into the bottom of the convection chamber (2) the cool air is warmed as it passes over the hot surfaces of the chamber and the hot air is then emitted back into the room via the top convection slot (3). Maximum heat is radiated into the room via the virtually invisible glass front (4). The Logic HE (balanced flue only) has been specifically designed with reduced depth to allow for easy installation into the internal skin of a traditional cavity wall.

\* Balanced flue models only.

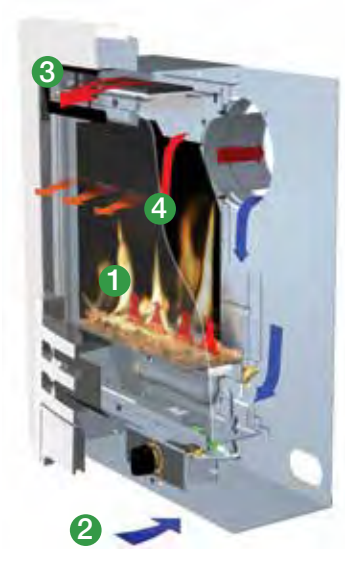

Balanced flue model shown.

Image left: Logic HE, conventional flue fire, coal fuel bed with Polished Chrome-effect Spanish front and Polished Steel-effect Box Profil2 frame. Also shown: Art Deco mantel from Stovax.

# Logic™ Control Options

The complete Logic family of fires are available with your choice of three different control systems; Manual Control, new Slide Control\* or for the ultimate luxury heating experience, a Remote Control to give convenient control from the comfort of your sofa.







## Manual Control

An easy to use system that allows for ignition, extinguish & full flame control all from a simple single control handle. To maintain the aesthetic appeal of your fire, the controls are discretely located behind the frame front at the bottom of the fire & can be accessed with ease.



## Slide Control

Gazco's new innovative Slide system has a subtly designed, ergonomic lever that is situated to the top right hand side of the fire's frame for easy access. The new Slide offers complete and convenient control over the fire, including ignition and extinguish along with flame height and corresponding heat levels, allowing you to achieve the warmth and ambiance you desire with minimal bending. Slide control Logic fires are available with a specific selection of frame styling options, please see page 22 for details.



## Remote Control

For the ultimate in comfort, opt for the Remote Control version. Once the pilot light has been ignited manually you can use Gazco's Standard Remote Control to vary the flame height and heat output from the comfort of your sofa, achieving the perfect ambiance, returning only to the fire when you are ready to turn it off.



*\*Slide Control is not available for the Logic Hotbox or Logic Convector fires with a Pebble Fuel effect.*



Logic HE fire, coal-effect fuel bed with Polished Chrome-effect **Arts front** and Polished Steel-effect **Box Profil2** frame. Also shown: Helsinki Mantel in Walnut finish (3563WW) from Stovax.

# Logic™ Hotbox

UP TO  
60%  
EFFICIENT 













## Conventional flue

- Radiant heating
- Heat reflective lining
- Fits into standard 410 x 560 x 250mm (w x h x d) fireplace opening
- No additional room ventilation normally required

For the complete selection of frames and fronts available with Logic Hotbox fires please see pages 22 - 25.



Above: Logic Hotbox fire, pebble fuel bed and Matt Black Arts front and Box Profil frame.  
Also shown: White Malmo mantel from Stovax and Kappa fireplace surround tiles (available from Gazco).

	Efficiency & Heat Output	Chimney or Flue Options				Gas Type		Fuel Bed		Control Options		
	E% <sup>†</sup> kW											
Logic Hotbox Conventional Flue	 60% 4.0kW	✓	✓	✓*	✗	✓	✓	✓	✓	✓	✓	✓

<sup>†</sup> Efficiency figures given are based upon the maximum heat output achieved in the options available for this model, for further technical information, please see pages 72 - 73.  
\*Min 16,500mm<sup>2</sup>



Logic Hotbox fire, coal fuel bed and Highlight Polished Arts front with Matt Black Arts frame with Slide Control. Also shown: Small Kensington mantel from Stovax.







# Logic™ Hotbox

UP TO  
60%  
EFFICIENT



## Conventional flue

- Radiant heating
- Heat reflective lining
- Fits into standard 410 x 560 x 250mm (w x h x d) fireplace opening
- No additional room ventilation normally required

For the complete selection of frames and fronts available with Logic Hotbox fires please see pages 22 - 25.



Logic Hotbox fire, coal fuel bed and **Dimension complete front**.  
Also shown: Brompton mantel from Stovax.

	Efficiency & Heat Output		Chimney or Flue Options				Gas Type		Fuel Bed		Control Options		
	E% <sup>†</sup>	kW											
Logic Hotbox Conventional Flue	60%	4.00kW	✓	✓	✓*	✗	✓	✓	✓	✓	✓	✓	✓

<sup>†</sup> Efficiency figures given are based upon the maximum heat output achieved in the options available for this model, for further technical information, please see pages 72 - 73.  
\*Min 16,500mm<sup>2</sup>

# Logic™ Convector

Conventional flue

**HIGH EFFICIENCY**  
UP TO 68.5%



- Radiant heating - plus convection system for added efficiency
- Heat reflective lining
- Fits into standard 410 x 560 x 250mm (w x h x d) fireplace opening
- No additional room ventilation normally required

For the complete selection of frames and fronts available with Logic Convector fires please see pages 22 - 25.



Logic Convector fire, coal fuel bed and Highlight Polished **Holyrood front** with Brushed Steel-effect **Box Profil frame** and Slide Control.  
Also Shown: Brompton Mantel and Chelsea Cast Iron front with inset panel available from Stovax.

	Efficiency & Heat Output	Chimney or Flue Options				Gas Type		Fuel Bed		Control Options		
	E% <sup>†</sup> kW	BRICK CHIMNEY	PRE-FABRICATED	PRE-CAST	BALANCED FLUE	NATURAL GAS	LPG GAS	COALS	PEBBLES	MANUAL	SLIDE	REMOTE
Logic Convector Conventional Flue	68.5% 4.60kW	✓	✓	✓*	X	✓	✓	✓	✓	✓	✓	✓

<sup>†</sup> Efficiency figures given are based upon the maximum heat output achieved in the options available for this model, for further technical information, please see pages 72 - 73.  
\*Min 16,500mm<sup>2</sup>





Logic Convector fire, coal fuel bed and **Winchester complete front** in Matt Black with Slide Control. Also shown: Victorian Corbel mantel in Antique White Marble and Fully Polished London Front with insert panel from Stovax



# Logic™ Convector

Conventional flue

**HIGH  
EFFICIENCY**  
UP TO 68.5%



- Radiant heating - plus convection system for added efficiency
- Heat reflective lining
- Fits into standard 410 x 560 x 250mm (w x h x d) fireplace opening
- No additional room ventilation normally required

For the complete selection of frames and fronts available with Logic Convector fires please see pages 22 - 25.



Logic Convector fire, coal fuel bed and Polished Brass-effect **Holyrood front** with Polished Brass-effect **Box Profil frame**. Also shown: Grafton Limestone mantel.

	Efficiency & Heat Output	Chimney or Flue Options				Gas Type		Fuel Bed		Control Options		
	E% <sup>†</sup> kW											
Logic Convector Conventional Flue	68.5% 4.60kW	✓	✓	✓*	✗	✓	✓	✓	✓	✓	✓	✓

<sup>†</sup> Efficiency figures given are based upon the maximum heat output achieved in the options available for this model, for further technical information, please see pages 72 - 73.

\*Min 16,500mm<sup>2</sup>

# Logic™ HE

## Conventional flue

**HIGH  
EFFICIENCY  
UP TO 89%**



- High efficiency fire with virtually invisible glass front
- Heat reflective lining
- Fits into standard 410 x 560 x 250mm (w x h x d) fireplace opening
- No additional room ventilation normally required
- Balanced flue model also available (see pages 20-21)

For the complete selection of frames and fronts available with Logic HE fires please see pages 22 - 25.



Logic HE Conventional flue fire, coal-effect fuel bed and **Designio2 Steel complete front** in Graphite with Slide Control.  
Also Shown: Slate Chiara Mosaic fire surround tile and Slate Chiara Bianco floor tile available from Gazco.

	Efficiency & Heat Output		Chimney or Flue Options				Gas Type		Fuel Bed		Control Options		
	E% †	kW	BRICK CHIMNEY	PRE-FABRICATED	PRE-CAST	BALANCED FLUE	NATURAL GAS	LPG GAS	COALS	WHITE STONES	MANUAL	SLIDE	REMOTE
Logic HE (Coals) Conventional Flue	89%	4.50kW	✓	✓	✓*	✗	✓	✓	✓	✗	✓	✓	✓
Logic HE (W.Stones) Conventional Flue	89%	3.80kW	✓	✓	✓*	✗	✓	✓	✗	✓	✓	✓	✓

† Efficiency figures given are based upon the maximum heat output achieved in the options available for this model, for further technical information, please see page 74 - 75.  
\*Min 16,500mm<sup>2</sup>





# Logic™ HE

## Balanced flue

**easyfit**  
Slimline Firebox

**HIGH EFFICIENCY**  
UP TO 86%



- High efficiency fire with virtually invisible glass front
- Heat reflective lining
- Fits into standard 410 x 560 x 250mm (w x h x d) fireplace opening
- No additional room ventilation normally required
- Slimmer depth, allowing installation into inner wall of home without the need of a false chimney breast.
- Conventional flue model also available (see pages 18-19)

For the complete selection of frames and fronts available with Logic HE fires please see pages 22 - 25.



Logic HE Balanced flue fire, white stone fuel bed and Polished Stainless **Tempo complete front** with Slide Control (GB Patent application No: 1108451.4)

	Efficiency & Heat Output		Chimney or Flue Options				Gas Type		Fuel Bed		Control Options		
	E% <sup>†</sup>	kW											
			BRICK CHIMNEY	PRE-FABRICATED	PRE-CAST	BALANCED FLUE	NATURAL GAS	LPG GAS	COALS	WHITE STONES	MANUAL	SLIDE	REMOTE
Logic HE (Coals) Balanced Flue	86%	3.40kW	X	X	X	✓	✓	✓	✓	X	✓	✓	✓
Logic HE (W.Stones) Balanced Flue	86%	2.92kW	X	X	X	✓	✓	X	✓		✓	✓	✓

<sup>†</sup> Efficiency figures given are based upon the maximum heat output achieved in the options available for this model, for further technical information, please see pages 74 - 75.





Logic HE Balanced flue fire, coal fuel bed, with Polished Chrome-effect **Arts front** and Polished Stainless Steel-effect **Box Profil2 frame**. Also shown: Malmo mantel from Stovax.

# Logic™ Front & Frame Choices

Manual & Remote Control Fires	Front Choices			Frame Choices				Complete Choices (Pages 24-25)									
	Holyrood	Spanish	Arts	Profil	Decorative	Arts	Box Profil	Dimension	Designio	Steel	Progress	Stockton Inset	Richmond	Winchester	Evolution	Tempo	Designio2
Logic Hotbox or Convector	✓	✓	✓	✓	✓	✓	✓	✓	✓	✗	✓	✗	✗	✓	✓	✗	✗
Logic HE (w/stones)	✗	✗	✓	✗	✗	✓	✓	✓	✓	✓	✓	✗	✗	✓	✓	✓	✓
Logic HE (coals)	✓	✓	✓	✗	✗	✓	✓	✓	✓	✗	✓	✓	✓	✓	✓	✓	✓
<b>Slide Control Fires</b>																	
Logic Hotbox or Convector	✓	✓	✓	✗	✗	✓	✓	✗	✗	✗	✗	✗	✗	✓	✗	✗	✗
Logic HE (w/stones)	✓	✓	✓	✗	✗	✓	✓	✗	✗	✗	✗	✗	✗	✓	✗	✓	✓
Logic HE (coals)	✓	✓	✓	✗	✗	✓	✓	✓	✓	✗	✓	✗	✗	✓	✗	✓	✓

## Arts Fronts

(Front cover & pages 9, 10, 11, 21, 29, 32, 46, 48 & 73)



Matt Black



Polished Brass-effect



Polished Chrome-effect



Highlight Polished

## Holyrood Fronts

(Pages 14, 17, 47 & 51)



Matt Black Cast Iron with Brass Finials†



Polished Brass-effect with Black columns & Brass-effect Finials†



Polished Chrome-effect & Polished Finials†



Highlight Polished

## Spanish Fronts

(Pages 6, 49 & 50)



Matt Black



Polished Brass-effect



Polished Chrome-effect



Highlight Polished

\* Logic HE versions have no finials.

† Finials are only available on Logic Hotbox and Logic Convactor fires when using Decorative or Profil frames

## Box Profil / Box Profil2<sup>†</sup> Frames

(Front cover & pages 6, 9, 10, 14, 17 & 21)



Matt Black<sup>†</sup>



Polished Brass-effect<sup>†</sup>



Polished Steel-effect<sup>†</sup>



Brushed Steel-effect<sup>†</sup>

## Arts / Arts2<sup>†</sup> Frames

(Pages 11, 29, 32 & 48)



Matt Black



Polished Brass



Polished Stainless Steel



Brushed Stainless Steel

## Decorative Frames



Matt Black



Polished Brass



Polished Stainless Steel



Brushed Stainless Steel

## Profil Frames

(Pages 46, 47 & 49)



Matt Black



Polished Brass\*



Polished Stainless Steel



Brushed Stainless Steel

\* Profil frame in Brass is available with both standard and wide (67mm) options.

† Box Profil2 and Arts2 frames are for the Logic HE fires and feature a beautifully crafted louvre as shown top right.

# Logic™ Complete Front Choices

## Designio

(Pages 12 & 33)



Graphite & Iridium

## Dimension/Dimension2\*



Matt Black†

(Page 13)

## Progress

(Page 19)



Iridium

## Stockton Inset

(Page 31)



Matt Black

## Richmond

(Page 28)



Black Cast Iron

## Tempo

(GB Patent application No: 1108451.4)

(Pages 4 & 20)



Polished Stainless, Brushed Stainless & Matt Black

## Evolution†

(Page 15)



Brushed Stainless Steel†

## Steel‡

(Pages 34 & 75)

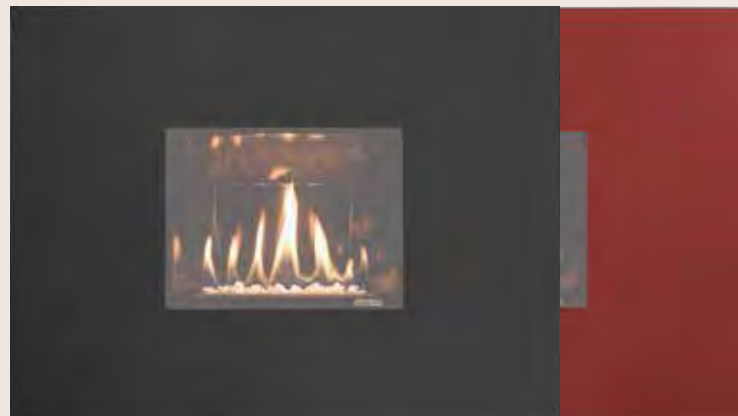

Graphite

Metallic Red

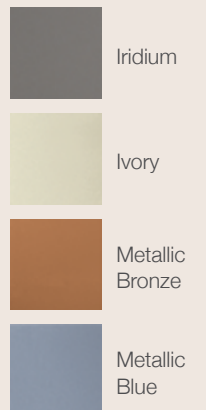

‡For more information on the four exciting new colour options for the Steel Front, please see page 75.

\* Dimension2 is for the Logic HE and features a beautifully crafted louvre as shown on the Tempo (above). † Logic HE versions have a cross bar and grille (as shown)





Logic HE fire, coal fuel bed and **Designio2 Steel complete front** in Iridium with Slide Control

### Designio2 Steel

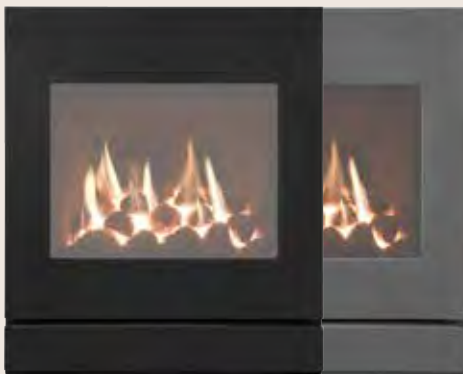

Graphite and Iridium

(Page 18 & 25)

### Designio2 Glass



Black Glass

(Page 8)

### Winchester<sup>†</sup>

(Page 16 & 26)



Polished<sup>†</sup> & Matt Black<sup>†</sup>

<sup>†</sup> Logic HE versions have a cross bar and grille (as shown)

E-Box™ Balanced Flue fire with coal fuel bed in Polished Winchester complete front.  
Also shown: Pembroke mantel and Belgravia Cast Iron Inset from Stovax.



# E-Studio™ & E-Box™ Fires

Quite simply, these fires offer you the benefits of high heating efficiency thus saving you money on your gas bills. This high efficiency technology comes with manual operation as standard, but can be upgraded with remote control options if you desire. With a host of frame choices and styles you can ensure warmth and elegance are brought into the very heart of your home, whether traditional or contemporary.



Conventional flue model shown.

## E-Box™



This premium 16" wide fire provides exceptional heating efficiency and fuel economy. Set behind a virtually invisible glass window, Gazco's technologically advanced E-Box™ offers ease of installation, a wide choice of styling options and a coal or pebble (1) version to suit all homes, even those without a chimney. The E-Box™ comes with manual operation as standard or you can opt for a Gazco command remote for ultimate comfort.

The E-Box™ produces an excellent heat output, offering up to 86% efficiency. Heat radiates from the glass window (2) and the fire has been expertly designed to convect heated air (3) into the room with maximum fuel efficiency.

\* *Balanced flue models only.*



Balanced flue model shown.

## E-Studio™



This top-of-the-range 16" wide fire provides exceptional heating efficiency with a fresh contemporary look. Set behind a virtually invisible glass window, the E-Studio™ features a stunning ribbon flame effect (1) and is available in both conventional and balanced flue models. E-Studio™ fires come with manual operation, but you can upgrade to one of Gazco's command remote controls for complete ease of use.

The high efficiency E-Studio™ radiates heat from its virtually invisible glass window (2) whilst the latest in firebox technology convects heated air directly into the room (3) for ultimate efficiency. There are a wide selection of stylish frame options to complement your E-Studio™ fire which can be found on pages 36-39.

\* *Balanced flue models only.*

## Command remote control options:

Gazco was the first UK company to introduce remote controls for gas fires. Today, our Command remote control systems allow both the E-Box™ & E-Studio™ fires to be upgraded, either at the time of purchase or at a later date, with either:



### Standard upgradable remote control

Once the pilot light has been ignited manually you can vary the flame height and heat output from the comfort of your armchair.



### Programmable remote control

This deluxe version has two additional features. The first allows you to thermostatically control the room temperature whilst the second allows you to programme your fire to switch itself on and off twice a day. Use both and you can even come home to a glowing fire that has heated the room to the temperature you select!





# E-Box™

**HIGH EFFICIENCY**  
UP TO 86%



## Conventional and Balanced flue

- High efficiency fire with virtually invisible glass front
- Radiant heating - plus convection system for added efficiency
- Heat reflective lining
- Fits into standard 410 x 560 x 250mm (w x h x d) fireplace opening
- No additional room ventilation normally required

Wide selection of frames and fronts available with E-Box fires - please see pages 36 - 39.



E-Box™ Balanced flue fire, coal fuel bed with Polished Chrome-effect Arts front and Polished Stainless Steel Arts2 frame. Also shown: Pembroke mantel from Stovax.

	Efficiency & Heat Output		Chimney or Flue Options				Gas Type		Fuel Bed		Control Options		
	E% <sup>†</sup>	kW <sup>†</sup>	BRICK CHIMNEY	PRE-FABRICATED	PRE-CAST	BALANCED FLUE	NATURAL GAS	LPG GAS	COALS	PEBBLES	MANUAL	UPGRADABLE	PROGRAMMABLE
E-Box™ Conventional Flue	76%	3.80kW	✓	✓	✓	✗	✓	✓	✓	✓	✓	✓	✓
E-Box™ Balanced Flue	86%	3.52kW	✗	✗	✗	✓	✓	✓	✓	✓	✓	✓	✓

† Efficiency figures given are based upon the maximum heat output achieved in the options available for this model, for complete technical information, please see pages 76 - 77.





# E-Box™

**HIGH  
EFFICIENCY  
UP TO 86%**



## Conventional and Balanced flue

- High efficiency fire with virtually invisible glass front
- Radiant heating - plus convection system for added efficiency
- Heat reflective lining
- Fits into standard 410 x 560 x 250mm (w x h x d) fireplace opening
- No additional room ventilation normally required

Wide selection of frames and fronts available with E-Box fires - please see pages 36 - 39.



E-Box™ Balanced flue fire, coal fuel bed and Stockton Inset complete front.

	Efficiency & Heat Output		Chimney or Flue Options				Gas Type		Fuel Bed		Control Options		
	E% <sup>†</sup>	kW <sup>†</sup>	BRICK CHIMNEY	PRE-FABRICATED	PRE-CAST	BALANCED FLUE	NATURAL GAS	LPG	COALS	PEBBLES	MANUAL	UPGRADABLE	PROGRAMMABLE
E-Box™ Conventional Flue	76%	3.80kW	✓	✓	✓	✗	✓	✓	✓	✓	✓	✓	✓
E-Box™ Balanced Flue	86%	3.52kW	✗	✗	✗	✓	✓	✓	✓	✓	✓	✓	✓

† Efficiency figures given are based upon the maximum heat output achieved in the options available for this model, for complete technical information, please see pages 76 - 77.

# E-Studio™

## Conventional and Balanced flue

**HIGH  
EFFICIENCY  
UP TO 82%**



- High efficiency fire with virtually invisible glass front
- Radiant heating - plus convection system for added efficiency
- Heat reflective lining
- Fits into standard 410 x 560 x 250mm (w x h x d) fireplace opening
- No additional room ventilation normally required

Wide selection of frames and fronts available with E-Studio fires - please see pages 36 - 39.



E-Studio™ fire with Polished Chrome-effect **Arts front** and Brushed Stainless Steel **Arts2 frame**.  
Also shown: Parisian White fireplace surround tiles (available from Gazco).

		Efficiency & Heat Output		Chimney or Flue Options				Gas Type		Fuel Bed	Control Options		
		E% <sup>†</sup>	kW	BRICK CHIMNEY	PRE-FABRICATED	PRE-CAST	BALANCED FLUE	NATURAL GAS	LPG GAS	WHITE STONES	MANUAL	UPGRADABLE	PROGRAMMABLE
E-Studio™ Conventional Flue		72%	3.10kW	✓	✓	✓*	✗	✓	✓	✓	✓	✓	✓
E-Studio™ Balanced Flue		82%	3.50kW	✗	✗	✗	✓	✓	✓	✓	✓	✓	✓

<sup>†</sup> Efficiency figures given are based upon the maximum heat output achieved in the options available for this model, for further technical information, please see pages 76-77.  
\*Min 16,500mm<sup>2</sup>







# E-Studio™

## Conventional and Balanced flue

**HIGH  
EFFICIENCY  
UP TO 82%**



- High efficiency fire with virtually invisible glass front
- Radiant heating - plus convection system for added efficiency
- Heat reflective lining
- Fits into standard 410 x 560 x 250mm (w x h x d) fireplace opening
- No additional room ventilation normally required

Wide selection of frames and fronts available with E-Studio fires - please see pages 36 - 39.



E-Studio™ fire with Futura complete front.

		Efficiency & Heat Output		Chimney or Flue Options				Gas Type		Fuel Bed	Control Options		
		E% <sup>†</sup>	kW										
				BRICK CHIMNEY	PRE-FABRICATED	PRE-CAST	BALANCED FLUE	NATURAL GAS	LPG GAS	WHITE STONES	MANUAL	UPGRADABLE	PROGRAMMABLE
E-Studio™ Conventional Flue		72%	3.10kW	✓	✓	✓*	✗	✓	✓	✓	✓	✓	✓
E-Studio™ Balanced Flue		82%	3.50kW	✗	✗	✗	✓	✓	✓	✓	✓	✓	✓

<sup>†</sup> Efficiency figures given are based upon the maximum heat output achieved in the options available for this model, for further technical information, please see pages 76-77.

\*Min 16,500mm<sup>2</sup>

# E-Box™ & E-Studio™ Frame & Front Choices

	Front Choices			Frame Choices		Complete Choices (Pages 38 - 39)										
	Holyrood	Spanish	Arts	Arts2	Box Profil2	Dimension2	Designio	Fusion	Futura	Stockton Inset	Steel	Progress	Winchester	Evolution	Richmond	Tempo
E-Box™	✓	✓	✓	✓	✓	✓	✓	✓	✓	✓	✗	✓	✓	✓	✓	✓
E-Studio™	✗	✗	✓	✓	✓	✓	✓	✓	✓	✗	✓	✓	✓	✓	✗	✓

## Box Profil2 Frames

(Front cover & pages 6, 9 & 21)



Matt Black



Polished Brass-effect



Polished Steel-effect



Brushed Steel-effect

## Arts2 Frames

(Pages 29 & 32)



Matt Black



Polished Brass



Polished Stainless Steel



Brushed Stainless Steel

## Holyrood Fronts

(Pages 14, 17, 47 & 51)



Matt Black Cast Iron



Polished Brass-effect with Black columns



Polished Chrome-effect



Highlight Polished

## Spanish Fronts

(Pages 6, 49 & 50)



Matt Black



Polished Brass-effect



Polished Chrome-effect



Highlight Polished

## Arts Fronts

(Front cover and pages 9, 10, 11, 21, 29, 32, 46, 48 & 73)



Matt Black



Polished Brass-effect



Polished Chrome-effect



Highlight Polished



# E-Box™ & E-Studio™ Complete Front Choices

Dimension2



Matt Black

Evolution (Page 15)



Brushed Stainless Steel

Richmond (Page 28)



Black Cast Iron

Winchester (Page 16 & 26)



Polished

Matt Black

Stockton Inset (Page 31)



Matt Black

Progress (Page 19)



Iridium

Designio (Page 12 & 33)



Graphite

Iridium

Tempo (GB Patent application No: 1108451.4) (Pages 4 & 20)



Polished Stainless, Brushed Stainless & Matt Black

## Fusion

(Page 70)



Iridium

(Page 30)



Graphite

## Futura

(Page 35)

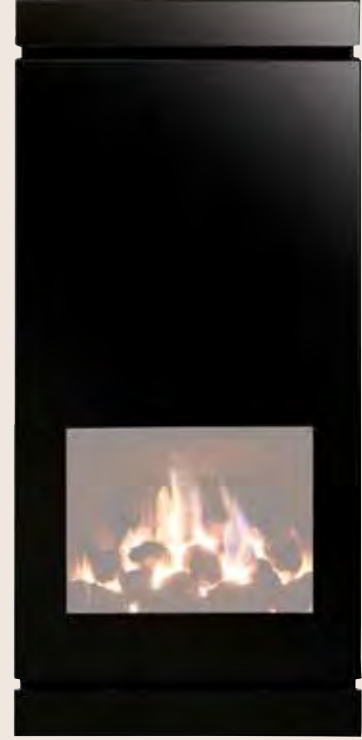

Black Glass

## Steel

(Page 34 & 75)



Graphite



Metallic Red



For more information on the four exciting new colour options for the Steel Front, please see page 75

# Riva2 500 Fires

With proportions thoughtfully designed to fit a standard 22" British fireplace opening, a stunningly realistic log-effect fuel bed and offered with a selection of stunning frames and lining options, the Riva2 500 has the potential not only for straight forward installation but a look that can be tailored to you home's decor.



# High Efficiency Premium Gas Fires...

Offering up to 4.8kW of high efficiency heat output, the Riva2 500 will provide cosy warmth for those cold winter evenings as well as the ambiance of a highly realistic log-effect fire with glowing ember bed. The Riva2 500 also comes with a Thermostatic remote to give you complete control over your fire from your sofa, for the ultimate in convenience and relaxation!



\* *Balanced flue models only.*

## Brick Effect



(Pages 40, 78 & 83)

## Black Reeded



(Pages 43 & 44)

## Vermiculite



(Pages 42 & 45)

## Lining Options

To enhance your styling possibilities and ensure you can achieve a look that will best suit you and your home, Gazco has developed three lining options, each providing an entirely different aesthetic for the stunning log-effect fire. Opt for the classic brick effect; the light and contemporary vermiculite or the timeless glamorous black reeded lining.

## Frame Options

Choose from the contemporary styling of the 'Edge' with its clean, frameless design for that 'hole in the wall' look or alternatively opt for one of Gazco's distinctive frames to extend your styling possibilities. Designed for hearth-mounting, the new Ellingham front is carefully crafted from cast iron and takes inspiration from Neo-Georgian architecture. The curved Verve XS is a modern, 3D frame in sophisticated Graphite that can be personalised by selecting from one of four additional colour finishes†: Metallic Red, Metallic Blue, Metallic Bronze and Ivory. To add a touch of sparkle to your living space, the Icon is a shining, reflective black glass frame that will create a real presence in your home with its clean, geometric lines.

### Edge (Pages 42 & 83)



### Ellingham (Pages 40 & 44)



Cast Iron

### Verve XS (Pages 43 & 78)



Graphite, Metallic Red, Metallic Blue, Metallic Bronze and Ivory†

### Icon (Page 45)



Black Glass

† For more information on the four exciting colour options for the Verve XS Frame, please see page 78

## Thermostatic Remote Control

The Riva2 500 comes with a programmable Thermostatic remote control, enabling you to enjoy the full functions of your fire from the comfort of your armchair or sofa.

The remote sports a number of impressive settings: you can set your fire to thermostatically maintain a specific room temperature of your choosing, or you can even programme your fire to a daily or weekly timer schedule for the ultimate in ease and convenience.

Should you mislay your handset, Riva2 500 fires also come complete with a flat Touch Control panel that can be discreetly wall mounted up to 2.5 metres away from the fire, allowing you to ignite, extinguish and control the flame height with ease.







# Riva2 500

Conventional and Balanced flue

**HIGH  
EFFICIENCY  
UP TO 82%**



- High efficiency fire with virtually invisible glass front
- Choice of three linings - Brick Effect, Black Reeded and Vermiculite
- Fits into standard 22" wide fireplace opening
- No additional room ventilation normally required

Wide selection of frames available with Riva2 500 fires - please see page 41.



Riva2 500 Verve XS in Graphite with Black Reeded Lining.  
For more information on the exciting colour options for the Riva2 500 Verve XS, please see page 78.

	Efficiency & Heat Output	Chimney or Flue Options			Gas Type		Fuel Bed	Lining Options			Control
	E% <sup>†</sup> kW	BRICK CHIMNEY	PRE-FABRICATED	BALANCED FLUE	NATURAL GAS	LPG GAS	LOGS	BRICK EFFECT	BLACK REEDED	VERMICULITE	THERMOSTATIC
Riva2 500 Conventional Flue	75%   4.80kW	✓	✓	✗	✓	✓	✓	✓	✓	✓	✓
Riva2 500 Balanced Flue	82%   4.80kW	✗	✗	✓	✓	✓	✓	✓	✓	✓	✓

<sup>†</sup> Efficiency figures given are based upon the maximum heat output achieved in the options available for this model, for further technical information, please see page 78.





# Riva2 500

Conventional and Balanced flue

**HIGH EFFICIENCY**  
UP TO 82%



- High efficiency fire with virtually invisible glass front
- Choice of three linings - Brick Effect, Black Reeded and Vermiculite
- Fits into standard 22" wide fireplace opening
- No additional room ventilation normally required

Wide selection of frames available with Riva2 500 fires - please see page 41.



Riva2 500 Icon with Vermiculite lining.  
Also shown: Pretoria Anthracite Polished and Durban White Matt fireplace surround tiles from Gazco.

	Efficiency & Heat Output	Chimney or Flue Options	Gas Type	Fuel Bed	Lining Options	Control
	E% <sup>†</sup> kW	BRICK CHIMNEY   PRE-FABRICATED   BALANCED FLUE	NATURAL GAS   LPG	LOGS	BRICK EFFECT   BLACK REEDED   VERMICULITE	THERMOSTATIC
Riva2 500 Conventional Flue	75%   4.80kW	✓   ✓   ✗	✓   ✓	✓	✓   ✓   ✓	✓
Riva2 500 Balanced Flue	82%   4.80kW	✗   ✗   ✓	✓   ✓	✓	✓   ✓   ✓	✓

<sup>†</sup> Efficiency figures given are based upon the maximum heat output achieved in the options available for this model, for further technical information, please see pages 78.



# VFC Fires

Available in 16" and 22" widths, the VFC range are our most versatile fires. With a slightly deeper fuel bed and featuring our unique variable flame technology, you can select between Blue (the fuel bed glows brightly with a lower, translucent flame with a hint of blue) or Yellow (flickering, yellow flames) effects with a simple lever control. A Tapered fire produces radiant heat, whilst the more efficient Convector produces radiant and convected heat.

# Convector or Tapered?

Conventional flue



VFC Convector fire with Highlight Polished **Holyrood** front and Polished Stainless Steel **Profil** frame. Also shown: Pembroke mantel from Stovax.

	VFC Tapered	VFC Convector
Suitable for conventional, brick built chimney (Class 1)	<b>CF</b>	
Chairbrick in place	Yes	Chairbrick removed
Optional Powered flue kit	No	Yes
Deeper fuel bed with VFC	Yes	Yes
16" and 22" widths	Yes	Yes
Heating type (efficiency)	Radiant (25%)	Radiant plus convection system (50%)
Reduce draft version (no room vent) available	Yes (16" only)	Yes (16" only)
Remote control option	Yes	Yes
Choice of frame and front styles	Yes	Yes

Image left: VFC Convector fire with Matt Black **Arts** front and **Profil** frame. Also shown: **Malmo** mantel from Stovax.



# VFC Convector

## Conventional flue

- Fits into standard 410 x 560 x 250mm (w x h x d) fireplace opening
- VFC (Variable Flame Control) system
- Radiant heating - plus convection system for added efficiency
- 16" and 22" versions available

Wide selection of frames and fronts available with VFC Convector fires please see pages 52 - 53.



VFC Convector fire with Highlight Polished Arts front and Polished Stainless Steel Arts frame. Also shown: Malmo mantel from Stovax.

	Efficiency & Heat Output		Chimney or Flue Options					Gas Type		Fuel Bed	Control Options	
	E% †	kW	BRICK CHIMNEY	PRE-FABRICATED	PRE-CAST	BALANCED FLUE	POWERED FLUE*	NATURAL GAS	LPG GAS	COALS	MANUAL	REMOTE
16" VFC Convector	50%	4.75kW	✓	✓	X	X	✓	✓	✓	✓	✓	✓
16" VFC Convector (Reduced Draft)	50%	3.43kW	✓	✓	X	X	✓	✓	✓	✓	✓	✓
22" VFC Convector	50%	6.35kW	✓	✓	X	X	✓	✓	✓	✓	✓	✓

† Efficiency figures given are based upon the maximum heat output achieved in the options available for this model, for further technical information, please see pages 79 - 80.

\*VFC Convector fires can be Power flued with an additional Powered Flue kit, please see page 79.



VFC Convector fire with Highlight Polished **Spanish front** and Polished Stainless Steel **Profil frame**. Also shown: Small Kensington mantel from Stovax.





# VFC Tapered

## Conventional flue

- Fits into standard chairbrick fireplace opening
- Radiant heating
- 16" and 22" versions available
- No additional room ventilation normally required (16" RD version only)

Wide selection of fronts available with VFC Tapered fires please see page 53.



22" VFC Tapered fire with Polished Brass-effect Holyrood front.

	Efficiency & Heat Output		Chimney or Flue Options					Gas Type		Fuel Bed	Control Options	
	E% <sup>†</sup>	kW	BRICK CHIMNEY	PRE-FABRICATED	PRE-CAST	BALANCED FLUE	POWERED FLUE	NATURAL GAS	LPG GAS	COALS	MANUAL	REMOTE
16" VFC Tapered	25%	2.40kW	✓	X	X	X	X	✓	✓	✓	✓	✓
16" VFC Tapered (Reduced Draft)	25%	1.70kW	✓	X	X	X	X	✓	✓	✓	✓	✓
22" VFC Tapered	25%	3.05kW	✓	X	X	X	X	✓	✓	✓	✓	✓

<sup>†</sup> Efficiency figures given are based upon the maximum heat output achieved in the options available for this model, for further technical information, please see pages 79 - 80.

# VFC Front & Frame Choices

	Front Choices			Frame Choices			Complete Choices (Page 53)				
	Holyrood	Spanish	Arts	Profil	Decorative	Arts	Designio	Progress	Evolution	Richmond	Box Profil & Arts Front
VFC Convector (16")	✓	✓	✓	✓	✓	✓	✓	✓	✓	✓	✓
VFC Convector (22")	✓	✓	✗	✓	✓	✗	✓	✓	✓	✗	✗
VFC Tapered (16")	✓	✓	✓	✗	✗	✗	✗	✗	✗	✗	✗
VFC Tapered (22")	✓	✓	✗	✗	✗	✗	✗	✗	✗	✗	✗

## Arts Fronts

(Front cover & pages 9, 10, 11, 21, 29, 32, 46, 48 & 73)



Matt Black



Polished Brass-effect



Polished Chrome-effect



Highlight Polished

## Holyrood Fronts

(Pages 14, 17, 47 & 51)



Matt Black Cast Iron



Polished Brass-effect with Black columns & Brass-effect Finials



Polished Chrome-effect



Highlight Polished

## Spanish Fronts

(Pages 6, 49 & 50)



Matt Black



Polished Brass-effect



Polished Chrome-effect



Highlight Polished

## Profil Frames

(Pages 46, 47 & 49)



\* Profil frame in Brass is also available with deeper 67mm profile.

Matt Black

Polished Brass\*

Polished Stainless Steel

Brushed Stainless Steel

## Arts Frames

(Page 11 & 48)



Matt Black

Polished Brass

Polished Stainless Steel

Brushed Stainless Steel

## Decorative Frames



Matt Black

Polished Brass

Polished Stainless Steel

Brushed Stainless Steel

## Complete Front Choices

Richmond (16") (Page 28)

Designio (16") (Pages 12 & 33)

Progress (16") (Page 19)

Evolution (16") (Page 15)



Black cast Iron



Graphite or Iridium



Iridium



Brushed Stainless Steel

Box Profil & Arts Front (16")

Designio (22")

Progress (22")

Evolution (22")



Polished Steel-effect



Graphite or Iridium



Iridium



Brushed Stainless Steel



# Classic Fireplaces

Cast Iron Convectors - Conventional flue



Above: Victorian Tiled Convector. Also shown: Georgian mantel in White from Stovax.

Offering the ultimate marriage of traditional style and modern technology, Gazco offer realistic coal and log gas fires for the Victorian Cast Iron fireplaces manufactured by our sister company Stovax. This allows you to enjoy quintessential period charm yet also benefit from the added efficiency and convenience of a Gazco gas fire, complete with remote control if you wish. Please ask your retailer for details or visit [www.gazco.com](http://www.gazco.com) for more information.





To enjoy the added efficiency and economy of convected heat, there are several models in the Classic Fireplaces range that can be fitted with one of Gazco's VFC Convector or Logic Convector fires as shown earlier in this brochure.



Above: Combination Convector in Highlight Polished finish with Urn design polished cast panels

Product Code	Description	Gas Type	Fuel Effect
8420UC	VFC Convector Manual	Nat. Gas	Coal
P8420UC	VFC Convector Manual	LPG	Coal
8421UC	VFC Convector Manual RD*	Nat. Gas	Coal
P8421UC	VFC Convector Manual RD*	LPG	Coal
8455	VFC Convector Remote Kit	-	-
101-295	Logic Convector Manual	Nat. Gas	Coal
101-418	Logic Convector Manual	LPG	Coal
101-349	Logic Convector with Remote	Nat. Gas	Coal
101-528	Logic Convector with Remote	LPG	Coal

**Available for:**

Victorian Convector

Art Nouveau Convector

Combination Convector

For further information and options please see the VFC and Logic technical information on pages 72 - 73 and 79 - 80.

\*VFC RD (Reduced Daught) and Logic models do not require additional room ventilation.



# Classic Fireplaces

Cast Iron Inserts & Fronts - Conventional flue



Above: Classic Arched Insert in highlight polished finish.  
Also shown: Victorian Corbel stone mantel in Antique White Marble from Stovax.

Gazco has developed a range of gas fires specifically designed for each of Stovax's Inset Fireplaces and Fronts. Depending on model, the highly realistic coal or log fires offer a superb combination of flame and glow with controllable heat output and the option of a convenient remote control.

For further information please see the Classic Fireplaces technical information on page 77.





Above: Regency Hob Grate in highlight polished finish with Ashpan cover. Also shown: Chatsworth Rich Oak mantel from Stovax.

To view the Stovax Classic Fireplaces brochure and see the full range of fireplaces on offer, simply scan this QR code, visit [www.gazco.com](http://www.gazco.com) or speak to your local Gazco retailer.



# Classic Fireplaces

Cast Iron Inserts & Fronts - Conventional flue



Above: Kensington Insert, fully Polished. Also shown: Sandringham Stone mantel in Natural Limestone from Stovax.

## Natural Gas

Product Code	Classic Fireplace	Fuel Effect
8000MCUC	Victorian Tiled Insert*	Coal
8210MCUC	Victorian Tiled Front	Coal
8002MCUC	Horseshoe Insert*	Coal
8004MCUC	Adelaide Insert*	Coal
8041MCUC	Regency Hob Grate	Coal
8062MCUC	Combination Insert*	Coal
8455	Remote Control Kit	-

## LPG

Product Code	Classic Fireplace	Fuel Effect
P8000MCUC	Victorian Tiled Insert*	Coal
P8210MCUC	Victorian Tiled Front	Coal
P8002MCUC	Horseshoe Insert*	Coal
P8004MCUC	Adelaide Insert*	Coal
P8041MCUC	Regency Hob Grate	Coal
P8062MCUC	Combination Insert*	Coal
8455	Remote Control Kit	-

CF





Above: Art Nouveau Tiled Front with Alphonse Mucha Nocturnal Slumber 5-tile sets. Also shown: Carlton Rich Oak mantel from Stovax.

### Natural Gas

Product Code	Classic Fireplace	Fuel Effect
8064MCUC	Arched Insert*	Coals
8102MCUC	Art Nouveau Insert*	Coals
8202MCUC	Art Nouveau Tiled Front	Coals
8300UC	Poppy & Wheatsheaf Tiled Front*	Coals
8301UC	Poppy & Wheatsheaf Tiled Front RD*	Coals
8023MCUC	Knightsbridge/Kensington Insert	Coals
8023LUC	Knightsbridge/Kensington Insert	Logs
8455	Remote Control Kit	-

### LPG

Product Code	Classic Fireplace	Fuel Effect
P8064MCUC	Arched Insert*	Coals
P8102MCUC	Art Nouveau Insert*	Coals
P8202MCUC	Art Nouveau Tiled Front	Coals
P8300UC	Poppy & Wheatsheaf Tiled Front*	Coals
P8301UC	Poppy & Wheatsheaf Tiled Front RD*	Coals
P8023MCUC	Knightsbridge/Kensington Insert	Coals
P8023LUC	Knightsbridge/Kensington Insert	Logs
8455	Remote Control Kit	-

\*Please affix RD to the end of product codes when ordering Reduced Draught models (with the exception of the Poppy & Wheatsheaf Tiled front which has a unique product code as shown above). Reduced draught models do not require additional room ventilation.





# Fire Baskets

We offer a superb range of fire baskets, each one handcrafted using traditional materials such as brass, steel, chrome and cast iron. Many are also offered in a choice of sizes and in a variety of casting shapes or finishes. In fact, there are almost 100 combinations from which to select the perfect fire basket for your fireplace.

According to the model, there is a choice of solid fuel and gas fire baskets so before you make your selection, speak to your local Gazco retailer about which option is right for you and your chimney.



1 Gas logs



2 Gas driftwood



3 Gas coals

## Fuels

### Wood, coal and smokeless fuels CF

All Gazco traditional fire baskets in this brochure are suitable for burning solid fuels such as logs and coal as well as approved smokeless fuels.

### Gas CF

All Gazco fire baskets can be specified for use with either Natural Gas or LPG. Natural Gas is provided through mains pipelines, whilst LPG is usually supplied to homes in rural areas from a tank in the garden or from gas bottles.

## Gas option

### Gas fires CF

Fires with gas logs (1) driftwood (2) or coals (3) are available for both natural gas and LPG. Please see page 80 for a full list of options.

Operation of your gas fire basket can be upgraded to Gazco's Standard Command remote control system. Once manually ignited, the handset allows you to alter flame height and heat output, all from the comfort of your armchair!

*If you have an existing grate or basket and would like the extra convenience of a gas fire, then Gazco can provide you with a **custom built, made-to-measure** fire in a choice of log, driftwood or coal effects. Please see pages 68 - 69 for details.*

For further information please see the Fire Baskets technical information on page 80.



# Fire Baskets



Above: Small Amhurst in Black Cast Iron with log effect gas fire.  
Also shown: Belgravia Front in Matt Black and Polished Insert from Stovax.



## Amhurst

Available in two sizes. Straight front in a choice of black cast iron or polished cast iron. Choose from all solid fuel or gas fire options.



## Art Deco

Available in two sizes. Straight front in a choice of black cast iron or cast iron with Polished Iron/Steel. Choose from all solid fuel or gas fire options.



## Ascot

One size. Straight front in a choice of brass or polished iron/steel. Choose from all solid fuel or gas fire options.



## Audley

One size. Straight front in a choice of brass or polished iron/steel. Choose from all solid fuel or gas fire options.



## Cheltenham

One size. Straight front in brass only. Choose from all solid fuel or gas fire options.



## Cromwell

Available in two sizes. Straight front in black cast iron only. Choose from all solid fuel or gas fire options.



### Halifax

One size. Straight front in brass or polished iron/steel. Choose from all solid fuel or gas fire options.



### Harlech

One size. Straight front in choice of brass or polished iron/steel. Choose from all solid fuel or gas fire options.



### Kendal

One size. Choice of straight or bowed front in brass. Choose from all solid fuel or gas fire options.



### Ludlow

One size. Bowed front in brass only. Choose from all solid fuel or gas fire options.



### Melbury

One size. Choice of straight or bowed front in brass or polished iron/steel. Choose from all solid fuel or gas fire options.



### Milan

Available in two sizes (15" or 18" grate size). Straight front in polished cast iron. Choose from all solid fuel or gas fire options.



# Fire Baskets



Above: Medium Milan with ashpan cover.  
Also shown: Belgravia polished cast front and  
Grafton stone mantel in Natural Limestone from Stovax.



# Fire Baskets



Above: Montrose in Brass with straight front.  
Also shown: Chelsea polished cast front and Cavendish Bolection stone mantel in Natural Limestone from Stovax

### Montrose

One size. Straight or bowed front in brass. Choose from all solid fuel or gas fire options.



### Portland

One size. Straight front in a choice of brass or polished iron/steel. Choose from all solid fuel or gas fire options.

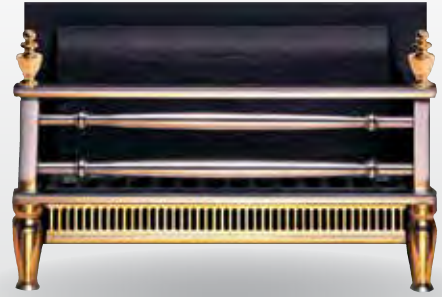

### Portland Extended

One size. Straight front in a choice of brass or polished iron/steel. Choose from all solid fuel or gas fire options.



### Rochester

One size. Straight front in choice of brass or polished iron/steel. Choose from all solid fuel or gas fire options.



### Spanish

Available in two sizes. Straight front in black or highlight polished cast iron and with a choice of two brass + two cast iron legs or four brass legs. Choose from all solid fuel or gas fire options.



### Stratford

Straight front in choice of brass or polished iron/steel. Choose from all solid fuel or gas fire options.



# Made To Measure



Gazco Made-To-Measure coal effect gas fire in an original grate & fireplace

## Radiant gas fires custom-built for your fireplace

Gazco offers a comprehensive made-to-measure service for living flame gas fires. A wide range of sizes are available, there is virtually no limit on shape and all are supplied with Gazco's class-leading fuel effects. This makes them ideal for everything from a small Victorian cast iron fireplace in a bedroom to a large centrepiece in a pub or restaurant.



# Features of our superb custom-built radiant Gas Fires include:

- Simple, multi-purpose manual control knob - for fingertip control of ignition, pilot light and gas supply
- Upgradable to Command remote control system
- Adjustable flame setting - variable between high and low to suit your mood
- Piezo ignition - automatic sparking without batteries or mains electricity
- Flame failure device - automatically shuts off the gas supply if the pilot light goes out
- Oxygen sensitive safety pilot - automatically shuts off the gas supply if the oxygen level in your room falls below a safe level
- Reduced Draught versions - no additional ventilation required
- Conventional Flue fires **CF**
- Natural Gas or LPG - versions available for both types of gas
- Heat outputs - around 2.5kW depending on model



This log-effect fire is in a Devon restaurant. Gazco made-to-measure fires are suitable for domestic and commercial use. Please ask your retailer for further information about sizes, shapes and installation regulations.



- 1). Log fuel effect
- 2). Driftwood fuel effect
- 3). Coal fuel effect



Gazco made-to-measure log-effect fire at Langs Hotel, Glasgow

The minimum and maximum sizes for made-to-measure gas fires are as follows:

Dimensions - with Manual Control						
	Coals		Logs		Driftwood	
	Minimum	Maximum	Minimum	Maximum	Minimum	Maximum
Width (mm)	165	610	230	840	230	840
Depth (mm)	130	319	155	375	155	375

Dimensions - with Manual Control upgradable to Command Remote						
	Coals		Logs		Driftwood	
	Minimum*	Maximum	Minimum*	Maximum	Minimum*	Maximum
Width (mm)	230	556	230	556	230	556
Depth (mm)	160	319	160	375	160	375

\*Trays with these dimensions will be supplied without legs.

Note: The sizes above are given as a guide only and are subject to the actual shape required. There are strict regulations regarding the installation of all gas fires including custom-built models. In particular, some openings will require some form of canopy to be fitted in order to comply with BS5871 (Part 3). Your Gazco retailer will be able to advise you about sizes, shapes, regulations etc. and to answer any other questions you may have.

# Technical Information

The information on the following pages is to assist you in your choice of a suitable Gazco inset fire. This is not intended to be all the information required to install your fire. This can be obtained from your local Gazco retailer or you can download the full installation instructions from the Gazco website at [www.gazco.com](http://www.gazco.com)



# Your chimney type

The type of chimney or flue you have usually dictates your choice of fire. To help you establish which fires are suitable for your home, please use the information and pictures below to identify your chimney. Don't worry if you don't have a chimney though, you can still find the perfect fire for your home!

## Conventional Flue CF

Conventional flue systems are easily recognisable as either a conventional brick or stone chimney, pre-fabricated or pre-cast chimney system. Should your home have none of these at present, it is usually possible to have a pre-fabricated system installed in your home if required.



Brick or Stone Chimney  
(Class 1)

The chimney stack rises well above the roofline and is topped by a traditional chimney pot or gas terminal. This type of chimney relies on the natural circulation of heated air to expel the products of combustion up your chimney.



Pre-Fabricated Flues  
(Class 1 & 2)

You will see a metal flue cowl on your roof. Some are all metal whilst others may terminate through a short rectangular pot (but without a chimney stack). These flues create the same circulation of heated air as a brick or stone chimney.



Pre-Cast flues  
(Class 2)

Many modern homes have been built with such flues. You can

readily identify them by either a metal flue cowl or a raised ridge terminal on your roof. Again, the natural circulation of heated air expels the products of combustion. Incidentally, these flues tend to be very shallow in depth so a slimmer fire is often required. Deep appliances, however, may be able to be installed with the use of either a spacer kit or deeper rebate on the fireplace. Please note that VFC fires are not suitable for older style pre-cast flues. Please consult your Gazco retailer for further information.

## Balanced Flue BF

Balanced flues work in conjunction with Gazco's Glass Fronted gas fires. The appliance is completely sealed from the room into which it is installed (so there are no draughts and heating efficiency is increased) and a twin-wall pipe vents directly to an outside wall.



Balanced Flue  
(No chimney required)

Air for combustion is drawn in through the outer pipe whilst the inner pipe removes the combustion gases to the exterior of the property. The twin-walled pipe will exit horizontally through an external wall. No electric supply is required therefore there is no sound with this flue system.



Powered Flue PF  
(No chimney required)

Suitable for Gazco's VFC Convector fires with an additional powered flue kit. A powered flue uses an extractor unit mounted to vent the combustion gases directly outside. This means that your fire does not have to be installed against an external wall, so it can be located in more rooms around your home. A mains electricity supply is needed to operate this system.

## No Air Vent required (UK)

Throughout this brochure, all fires shown with this symbol have the advantage of not normally requiring an air vent\* where the air permeability is greater than  $5.0\text{m}^3/\text{hr}/\text{m}^2$ . Please discuss this in full with your local retailer.



\*Requirements in the Republic of Ireland are different.



# Logic™ Hotbox and Convector Fires

## LOGIC™ HOTBOX FIRE INFORMATION

Product Code	Controls	Flue Type	Gas Type	Fuel Effect	Heat Input (kW)	Heat Output (kW)	Efficiency	Opening Size (mm)		
								w	h	d
Logic Hotbox - Manual Control										
101-021	Manual	Class 1 & 2	Nat. Gas	Coals	6.70	4.00	60%	410	560	250
101-512	Manual	Class 1 & 2	LPG	Coals	6.70	4.00	60%	410	560	250
101-372	Manual	Class 1 & 2	Nat. Gas	Pebbles	6.70	4.00	60%	410	560	250
101-788	Manual	Class 1 & 2	LPG	Pebbles	6.70	4.00	60%	410	560	250
Logic Hotbox - Slide Control										
101-224	Slide	Class 1 & 2	Nat. Gas	Coals	6.60	3.96	60%	410	560	250
101-519	Slide	Class 1 & 2	LPG	Coals	6.70	4.00	60%	410	560	250
Logic Hotbox - Remote Control										
101-083	Remote	Class 1 & 2	Nat. Gas	Coals	6.70	4.00	60%	410	560	250
101-741	Remote	Class 1 & 2	LPG	Coals	6.70	4.00	60%	410	560	250
101-278	Remote	Class 1 & 2	Nat. Gas	Pebbles	6.70	4.00	60%	410	560	250
101-589	Remote	Class 1 & 2	LPG	Pebbles	6.70	4.00	60%	410	560	250

## LOGIC™ CONVECTOR FIRE INFORMATION

Product Code	Controls	Flue Type	Gas Type	Fuel Effect	Heat Input (kW)	Heat Output (kW)	Efficiency	Opening Size (mm)		
								w	h	d
Logic Convector - Manual Control										
101-295	Manual	Class 1 & 2	Nat. Gas	Coals	6.70	4.60	68.5%	410	560	250
101-418	Manual	Class 1 & 2	LPG	Coals	6.70	4.60	68.5%	410	560	250
101-100	Manual	Class 1 & 2	Nat. Gas	Pebbles	6.70	4.60	68.5%	410	560	250
101-636	Manual	Class 1 & 2	LPG	Pebbles	6.70	4.60	68.5%	410	560	250
Logic Convector - Slide Control										
101-053	Slide	Class 1 & 2	Nat. Gas	Coals	6.60	4.52	68.5%	410	560	250
101-796	Slide	Class 1 & 2	LPG	Coals	6.70	4.60	68.5%	410	560	250
Logic Convector - Remote Control										
101-349	Remote	Class 1 & 2	Nat. Gas	Coals	6.70	4.60	68.5%	410	560	250
101-528	Remote	Class 1 & 2	LPG	Coals	6.70	4.60	68.5%	410	560	250
101-190	Remote	Class 1 & 2	Nat. Gas	Pebbles	6.70	4.60	68.5%	410	560	250
101-434	Remote	Class 1 & 2	LPG	Pebbles	6.70	4.60	68.5%	410	560	250

## COMPLETE FRONT & FRAME INFORMATION FOR LOGIC™ HOTBOX AND LOGIC™ CONVECTOR FIRES

Product Code	Description	Frame Finish	Frame Size (mm)		
			w	h	d
Complete Front Choice for Manual and Remote Models					
8251GP	Designio	Graphite	595	615	68
8251IR	Designio	Iridium	595	615	68
8681MB	Dimension	Matt Black	540	635	68
8255BS	Evolution (Hotbox)	Stainless Steel	489	597	45
8257BS	Evolution (Convector)	Stainless Steel	489	597	45
8253IR	Progress	Iridium	520	598	60
8698MB	Winchester	Matt Black	508	619	55
8698P	Winchester	Polished	508	619	55

Product Code	Description	Frame Finish	Frame Size (mm)	
			w	h
Fire Frame Choice for Manual and Remote Control Fires				
901-219	Box Profil frame	Matt Black	503	604
901-178	Box Profil frame	Polished Brass-effect	503	604
901-269	Box Profil frame	Polished Stainless Steel-effect	503	604
901-344	Box Profil frame	Brushed Stainless Steel-effect	503	604
8284MB	Arts frame	Matt Black	503	605
8284PBR	Arts frame	Polished Brass	503	605
8284P	Arts frame	Polished Stainless Steel	503	605
8284BS	Arts frame	Brushed Stainless Steel	503	605
8285	Decorative frame	Matt Black	505	610
8266	Decorative frame	Polished Brass	505	610
8232	Decorative frame	Polished Stainless Steel	505	610
8235	Decorative frame	Brushed Stainless Steel	505	610
8345	Profil (Standard) frame	Matt Black	490	600
8340	Profil (Standard) frame	Polished Brass	490	600
8342	Profil (Standard) frame	Polished Stainless Steel	490	600
8229	Profil (Standard) frame	Brushed Stainless Steel	490	600
8280	Profil (Wide) frame	Polished Brass	527	615

Product Code	Description	Frame Finish	Frame Size (mm)		
			w	h	d
Complete Front Choice for Slide Models					
901-335	Winchester	Matt Black	508	619	55
901-347	Winchester	Polished	508	619	55

Product Code	Description	Frame Finish	Frame Size (mm)	
			w	h
Fire Frame Choice for Slide Control Fires				
901-223	Box Profil frame	Matt Black	503	605
901-239	Box Profil frame	Polished Brass effect	503	605
901-244	Box Profil frame	Polished Steel effect	503	605
901-251	Box Profil frame	Brushed Steel effect	503	605
901-021	Arts frame	Matt Black	503	604
901-058	Arts frame	Polished Brass	503	604
901-087	Arts frame	Polished Stainless Steel	503	604
901-111	Arts frame	Brushed Stainless Steel	503	604

## FRET INFORMATION FOR LOGIC™ HOTBOX AND LOGIC™ CONVECTOR FIRES

Product Code	Description	Fret Finish	Frame Size (mm)		Product Code	Description	Fret Finish	Frame Size (mm)	
			w	h				w	h
<b>Fire Fret Choice for Manual, Slide &amp; Remote Fires (if using a Box Profil or Arts frame)</b>					<b>Fire Fret Choice for Manual &amp; Remote Fires (if using a Decorative or Profil frame)</b>				
901-425	Arts fire front†	Matt Black	390	230	901-425	Arts fire front†	Matt Black	390	230
901-530	Arts fire front†	Polished Brass-effect	390	230	901-530	Arts fire front†	Polished Brass-effect	390	230
901-476	Arts fire front†	Polished Chrome-effect	390	230	901-476	Arts fire front†	Polished Chrome-effect	390	230
901-296	Arts fire front†	Highlight Polished	390	230	901-296	Arts fire front†	Highlight Polished	390	230
901-338	Holyrood fire front	Matt Black	385	265	901-012	Holyrood fire front	Matt Black with Brass finials	385	265
901-193	Holyrood fire front	Polished Brass with black columns	385	265	901-042	Holyrood fire front	Polished Brass-effect - black columns & brass-effect finials	385	265
901-175	Holyrood fire front	Highlight Polished	385	210	901-102	Holyrood fire front	Highlight Polished	385	210
901-074	Holyrood fire front	Polished Chrome-effect	385	210	901-147	Holyrood fire front	Polished Chrome-effect	385	210
901-161	Spanish fire front	Matt Black	385	210	901-008	Spanish fire front	Matt Black	385	210
901-212	Spanish fire front	Polished Brass-effect	385	210	901-085	Spanish fire front	Polished Brass-effect	385	210
901-188	Spanish fire front	Highlight Polished	385	210	901-037	Spanish fire front	Highlight Polished	385	210
901-281	Spanish fire front	Polished Chrome-effect	385	210	901-129	Spanish fire front	Polished Chrome-effect	385	210

## OPTIONS AND ACCESSORIES

Product Code	Description
8315	Spacer kit (75mm) for Logic Hotbox and Logic Convector

† NB: If the Arts front is ordered with a Decorative or Profil frame, a fixing kit (8289) will be supplied free of charge.

## ADDITIONAL INFORMATION FOR LOGIC™ HOTBOX & CONVECTOR FIRES

If you are fitting a Decorative or Profil frame with an Arts Front, an additional fitting kit will be provided to ease installation.

You can install a Logic Convector Fire with a Stovax Cast Iron Victorian, Art Nouveau or Combination Fireplace.

Conventional Logic Hotbox and Logic Convector fires require 5" minimum flue sizes.

Please consult your local Gazco and Stovax dealer for further information.

Installation of Logic Hotbox or Logic Convector into Pre Cast Flues (minimum 16,500mm<sup>2</sup>)

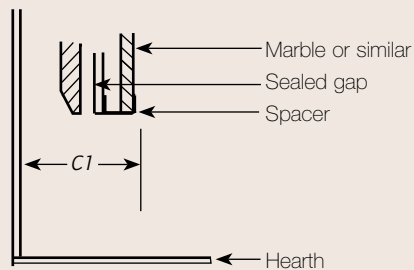

If your chimney has a shallow 'starter block' then use spacer kit 8315 and a 3" (75mm) deep rebate surround to achieve the C1 dimension. Pre-cast flues with a deep 'starter block' may be installed in exactly the same way as a conventional masonry opening providing there is a depth of 8½" (215mm) at C1.

Diagrammatic representation only. Not accurate for installation purposes.



# Logic™ HE Convector Fires

## LOGIC™ HE FIRE INFORMATION

Product Code	Flue Type	Gas Type	Fuel Effect	Heat Input (kW)	Heat Output (kW)	Efficiency	Control	Opening Size (mm)		
								w	h	d
<b>Logic HE Convector - Manual Control</b>										
101-151	Class 1 & 2	Nat. Gas	Coals	5.10	4.54	89%	Manual	410	560	250
101-497	Class 1 & 2	LPG	Coals	4.80	4.27	89%	Manual	410	560	250
101-324	Class 1 & 2	Nat. Gas	White Stones	4.30	3.82	89%	Manual	410	560	250
101-651	Class 1 & 2	LPG	White Stones	4.30	3.82	89%	Manual	410	560	250
101-135	Balanced flue	Nat. Gas	Coals	4.00	3.45	86%	Manual	420	560	165
101-458	Balanced flue	LPG	Coals	4.00	3.45	86%	Manual	420	560	165
101-208	Balanced flue	Nat. Gas	White Stones	3.40	2.92	86%	Manual	420	560	165
101-687	Balanced flue	LPG	White Stones	3.40	2.92	86%	Manual	420	560	165
<b>Logic HE Convector - Slide Control</b>										
101-037	Class 1 & 2	Nat. Gas	Coals	5.10	4.54	89%	Slide	410	560	250
101-444	Class 1 & 2	LPG	Coals	4.90	4.36	89%	Slide	410	560	250
101-110	Class 1 & 2	Nat. Gas	White Stones	4.10	3.65	89%	Slide	410	560	250
101-597	Class 1 & 2	LPG	White Stones	4.30	3.82	89%	Slide	410	560	250
101-237	Balanced flue	Nat. Gas	Coals	4.10	3.52	86%	Slide	420	560	165
101-639	Balanced flue	LPG	Coals	4.10	3.52	86%	Slide	420	560	165
101-386	Balanced flue	Nat. Gas	White Stones	3.40	2.92	86%	Slide	420	560	165
101-753	Balanced flue	LPG	White Stones	3.40	2.92	86%	Slide	420	560	165
<b>Logic HE Convector - Remote Control</b>										
101-088	Class 1 & 2	Nat. Gas	Coals	5.10	4.54	89%	Remote	410	560	250
101-614	Class 1 & 2	LPG	Coals	4.80	4.27	89%	Remote	410	560	250
101-131	Class 1 & 2	Nat. Gas	White Stones	4.10	3.65	89%	Remote	410	560	250
101-649	Class 1 & 2	LPG	White Stones	4.30	3.82	89%	Remote	410	560	250
101-174	Balanced flue	Nat. Gas	Coals	4.20	3.60	86%	Remote	420	560	165
101-738	Balanced flue	LPG	Coals	4.10	3.52	86%	Remote	420	560	165
101-182	Balanced flue	Nat. Gas	White Stones	3.40	2.92	86%	Remote	420	560	165
101-777	Balanced flue	LPG	White Stones	3.40	2.92	86%	Remote	420	560	165

## COMPLETE FRONT INFORMATION FOR LOGIC™ HE CONVECTOR FIRES

Product Code	Description	Frame Finish	Frame Size (mm)			Product Code	Description	Frame Finish	Frame Size (mm)		
			w	h	d				w	h	d
<b>Complete Front Choice for Manual and Remote Control Models</b>						<b>Complete Front Choice for Slide Control Models</b>					
912-396	Designio	Graphite	595	615	68	901-369	Winchester	Matt Black	508	619	55
912-018	Designio	Iridium	595	615	68	901-372	Winchester	Polished	508	619	55
912-322	Dimension2	Matt Black	540	635	68	901-385	Tempo	Matt Black	503	604	51
912-239	Progress	Iridium	520	598	60	901-403	Tempo	Polished Stainless	503	604	51
8697MB	Winchester	Matt Black	508	619	55	901-414	Tempo	Brushed Stainless	503	604	51
8697HP	Winchester	Polished	508	619	55	901-539	Designio2 Steel	Graphite	519	606	40
8695GP	Steel†*	Graphite	850	670	32	901-580	Designio2 Steel	Iridium	519	606	40
8695IR	Steel†*	Iridium	850	670	32	901-643	Designio2 Glass	Black Glass	519	606	40
912-601	Evolution	Stainless Steel	489	597	45						
912-197	Tempo	Matt Black	503	604	51						
912-221	Tempo	Polished Stainless	503	604	51						
912-316	Tempo	Brushed Stainless	503	604	51						
901-492	Designio2 Steel	Graphite	519	606	40						
901-511	Designio2 Steel	Iridium	519	606	40						
901-526	Designio2 Glass	Black Glass	519	606	40						
8696	Stockton Inset front <sup>A</sup>	Black Cast Iron	529	601	128						
8679	Richmond front <sup>A</sup>	Black Cast Iron	540	665	50						

† For details on how to order a Steel front in other colour options please see page 75.

\* White stone Logic HE only. <sup>A</sup> Coal Logic HE only.

## FRET INFORMATION FOR LOGIC™ HE CONVECTOR FIRES

Product Code	Description	Fret Finish	Frame Size (mm)		Product Code	Description	Fret Finish	Frame Size (mm)	
			w	h				w	h
<b>Fret Choice for Manual, Slide and Remote Control Models</b>									
901-425	Arts front	Matt Black	390	230	912-257	Holyrood front	Highlight Polished	385	210
901-530	Arts front	Polished Brass-effect	390	230	912-392	Holyrood front	Polished Chrome-effect	385	210
901-476	Arts front	Polished Chrome-effect	390	230	912-083	Spanish front	Matt Black	385	210
901-296	Arts front	Highlight Polished	390	230	912-127	Spanish front	Highlight Polished	385	210
912-020	Holyrood front	Matt Black	385	210	912-160	Spanish front	Polished Brass-effect	385	210
912-226	Holyrood front	Polished Brass-effect with black columns	385	210	912-216	Spanish front	Polished Chrome-effect	385	210



## FRAME INFORMATION FOR LOGIC™ HE CONVECTOR FIRES

Product Code	Description	Frame Finish	Frame Size (mm)	
			w	h

### Frame Choice for Manual and Remote Control Models

912-232	Box Profil2 frame	Matt Black	503	604
912-140	Box Profil2 frame	Polished Brass-effect	503	604
912-027	Box Profil2 frame	Polished Steel-effect	503	604
912-358	Box Profil2 frame	Brushed Steel-effect	503	604
912-862	Arts2 frame	Matt Black	503	605
912-508	Arts2 frame	Polished Brass	503	605
912-914	Arts2 frame	Polished Stainless Steel	503	605
912-268	Arts2 frame	Brushed Stainless Steel	503	605

### Frame Choice for Slide Control Models

901-272	Box Profil2 frame	Matt Black	503	604
901-286	Box Profil2 frame	Polished Brass-effect	503	604
901-299	Box Profil2 frame	Polished Steel-effect	503	604
901-310	Box Profil2 frame	Brushed Steel-effect	503	604
901-167	Arts2 frame	Matt Black	503	605
901-194	Arts2 frame	Polished Brass	503	605
901-206	Arts2 frame	Polished Stainless Steel	503	605
901-214	Arts2 frame	Brushed Stainless Steel	503	605

## ADDITIONAL INFORMATION

Logic HE Balanced Flue

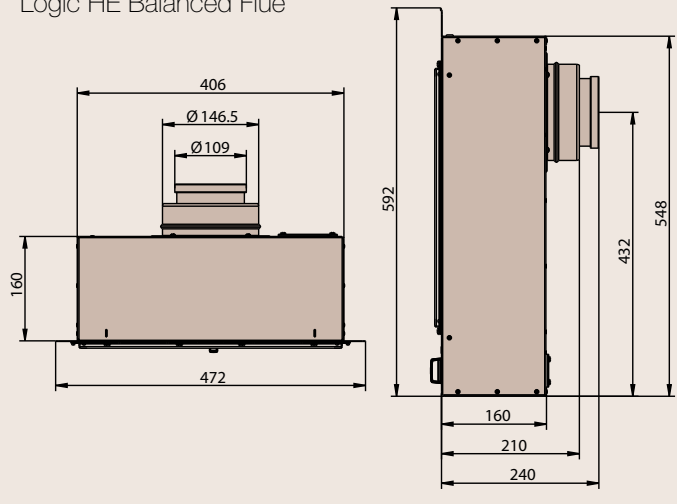

## Coloured Front options for Logic™ HE & E-Studio™ Steel



Logic HE fire with white stone fuel bed and **Steel complete front** in Metallic Red

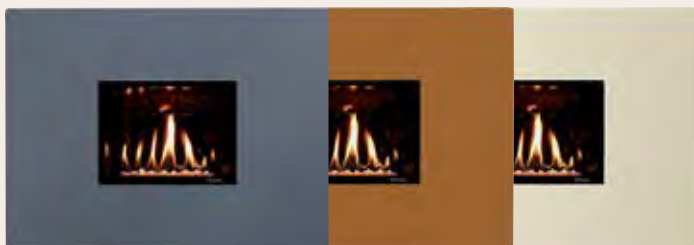

Metallic Blue

Metallic Bronze

Ivory

Please use the product code provided for the Graphite model along with the following suffix for your choice of colour: Metallic Red (RD), Metallic Blue (BL), Metallic Bronze (BZ) and Ivory (IV).

- for example: Logic HE Steel in Ivory = 8695GPV

# E-Box™

## E-BOX™ FIRE INFORMATION

Product Code	Description	Flue Type	Gas Type	Fuel Effect	Heat Input (kW)	Heat Output (kW)	Efficiency	Remote Control	Opening Size (mm)		
									w	h	d
⊗ 8691MCUC	E-Box™	Class 1 & 2	Nat. Gas	Coals	5.10	3.80	76%	Upgradable	410	560	250
⊗ P8691MCUC	E-Box™	Class 1 & 2	LPG	Coals	4.80	3.70	76%	Upgradable	410	560	250
⊗ 8691PBUC	E-Box™	Class 1 & 2	Nat. Gas	Pebbles	5.10	3.80	76%	Upgradable	410	560	250
⊗ P8691PBUC	E-Box™	Class 1 & 2	LPG	Pebbles	4.80	3.70	76%	Upgradable	410	560	250
⊗ 8692MCUC	E-Box™	Balanced flue	Nat. Gas	Coals	4.10	3.52	86%	Upgradable	410	560	235
⊗ P8692MCUC	E-Box™	Balanced flue	LPG	Coals	4.10	3.52	86%	Upgradable	410	560	235
⊗ 8692PBUC	E-Box™	Balanced flue	Nat. Gas	Pebbles	4.10	3.52	86%	Upgradable	410	560	235
⊗ P8692PBUC	E-Box™	Balanced flue	LPG	Pebbles	4.10	3.52	86%	Upgradable	410	560	235

## FRAME AND FRONT INFORMATION

Product Code	Description	Frame Finish	Frame Size (mm)		
			w	h	d
<b>Complete Front Choice</b>					
8699GP	Fusion	Graphite	520	1127	38
8699IR	Fusion	Iridium	520	1127	38
8687BK	Futura	Black Glass	520	1127	48
912-396	Designio front	Graphite	595	615	68
912-018	Designio front	Iridium	595	615	68
912-322	Dimension2 front	Matt Black	540	635	68
912-601	Evolution front	Stainless Steel	489	597	45
912-239	Progress front	Iridium	520	598	60
8679	Richmond front	Black Cast Iron	540	665	50
8696	Stockton Inset front	Black Cast Iron	529	601	128
8697MB	Winchester	Matt Black	508	619	55
8697HP	Winchester	Polished	508	619	55
912-197	Tempo	Matt Black	503	604	51
912-221	Tempo	Polished Stainless	503	604	51
912-316	Tempo	Brushed Stainless	503	604	51

Product Code	Description	Frame Finish	Frame Size (mm)	
			w	h
<b>Fire Frame Choice</b>				
912-862	Arts2 frame	Matt Black	503	605
912-508	Arts2 frame	Polished Brass	503	605
912-914	Arts2 frame	Polished Stainless Steel	503	605
912-268	Arts2 frame	Brushed Stainless Steel	503	605
912-232	Box Profil2 frame	Matt Black	503	604
912-140	Box Profil2 frame	Polished Brass-effect	503	604
912-027	Box Profil2 frame	Polished Steel-effect	503	604
912-358	Box Profil2 frame	Brushed Steel-effect	503	604

Product Code	Description	Frame Finish	Frame Size (mm)	
			w	h
<b>Fire Front Choice</b>				
901-425	Arts front	Matt Black	390	230
901-296	Arts front	Highlight Polished	390	230
901-530	Arts front	Polished Brass-effect	390	230
901-476	Arts front	Polished Chrome-effect	390	230
912-020	Holyrood front	Matt Black	385	210
912-226	Holyrood front	Polished Brass-effect with black columns	385	210
912-257	Holyrood front	Highlight Polished	385	210
912-392	Holyrood front	Polished Chrome-effect	385	210
912-083	Spanish front	Matt Black	385	210
912-127	Spanish front	Highlight Polished	385	210
912-160	Spanish front	Polished Brass-effect	385	210
912-216	Spanish front	Polished Chrome-effect	385	210

## REMOTE CONTROL OPTIONS & ACCESSORIES

Product Code	Description
8315	Spacer kit (75mm) for conventional flue E-Box™
8455	Standard remote control kit
8456	Programmable thermostatic remote control kit

# E-Studio™

## E-STUDIO™ FIRE INFORMATION

Product Code	Description	Flue Type	Gas Type	Fuel Effect	Heat Input (kW)	Heat Output (kW)	Efficiency	Remote Control	Opening Size (mm)		
									w	h	d
⊗ 8691CFCHUC	E-Studio™	Class 1 & 2	Nat. Gas	White Stones	4.30	3.10	72%	Upgradable	410	560	250
⊗ P8691CFCHUC	E-Studio™	Class 1 & 2	LPG	White Stones	4.30	3.10	72%	Upgradable	410	560	250
⊗ 8692BFCHUC	E-Studio™	Balanced flue	Nat. Gas	White Stones	4.30	3.50	82%	Upgradable	410	560	235
⊗ P8692BFCHUC	E-Studio™	Balanced flue	LPG	White Stones	3.75	3.00	79%	Upgradable	410	560	235

## FRAME AND FRONT INFORMATION

Product Code	Description	Frame Finish	Frame Size (mm)		
			w	h	d
<b>Complete Front Choice</b>					
8699GP	Fusion	Graphite	520	1127	38
8699IR	Fusion	Iridium	520	1127	38
8687BK	Futura	Black Glass	520	1127	48
912-396	Designio	Graphite	595	615	68
912-018	Designio	Iridium	595	615	68
912-322	Dimension2	Matt Black	540	635	68
912-601	Evolution	Stainless Steel	489	597	45
912-239	Progress	Iridium	520	598	60
8695GP	Steel†	Graphite	850	670	32
8695IR	Steel†	Iridium	850	670	32
8697MB	Winchester	Matt Black	508	619	55
8697HP	Winchester	Polished	508	619	55
912-197	Tempo	Matt Black	503	604	51
912-221	Tempo	Polished Stainless	503	604	51
912-316	Tempo	Brushed Stainless	503	604	51

Product Code	Description	Frame Finish	Frame Size (mm)	
			w	h
<b>Fire Frame Choice</b>				
912-862	Arts2 frame	Matt Black	503	605
912-508	Arts2 frame	Polished Brass	503	605
912-914	Arts2 frame	Polished Stainless Steel	503	605
912-268	Arts2 frame	Brushed Stainless Steel	503	605
912-232	Box Profil2 frame	Matt Black	503	604
912-140	Box Profil2 frame	Polished Brass-effect	503	604
912-027	Box Profil2 frame	Polished Steel-effect	503	604
912-358	Box Profil2 frame	Brushed Steel-effect	503	604

Product Code	Description	Frame Finish	Frame Size (mm)	
			w	h
<b>Fire Front Choice</b>				
901-425	Arts fire front	Matt Black	390	230
901-296	Arts fire front	Highlight Polished	390	230
901-530	Arts fire front	Polished Brass-effect	390	230
901-476	Arts fire front	Polished Chrome-effect	390	230

## REMOTE CONTROL OPTIONS

Product Code	Description
8455	Standard remote control kit
8456	Programmable Thermostatic remote control kit

† For details on how to order a Steel front in other colour options please see page 75.

## ADDITIONAL INFORMATION

### Installation of E-Box™ and E-Studio™ Conventional Flues into Pre-cast Flue installations. (minimum 16,500mm<sup>2</sup>)

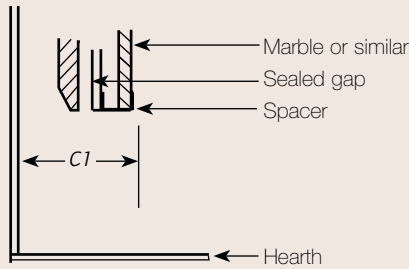

If your chimney has a shallow 'starter block' then use spacer kit 8315 and a 3" (75mm) deep rebate surround to achieve the C1 dimension. Pre-cast flues with a deep 'starter block' may be installed in exactly the same way as a conventional masonry opening providing there is a depth of 8½" (215mm) at C1.

### Installation of E-Box™ and E-Studio™ Balanced Flue\*

Overall external dimensions (mm)

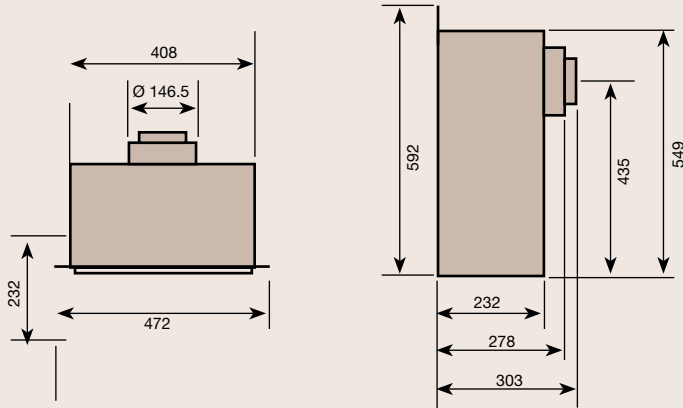

Min and max flue size length (mm)

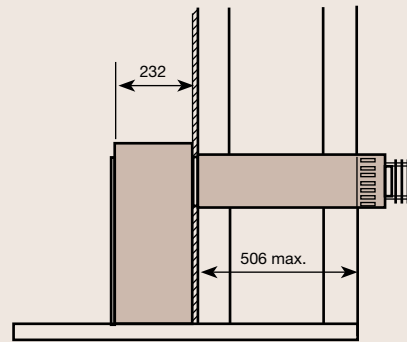

**Additional Note:** Conventional E-Box™ and E-Studio™ fires require a minimum flue size of 5".

Diagrammatic representation only. Not accurate for installation purposes.

E-Box™ and E-Studio™ Balanced Flue

Minimum Flue Length = 88mm

Maximum Flue Length = 506mm

Recessed in to a cavity or a false chimney breast

\* For more Balanced Flue information and options please refer to our Concentric Flue System brochure which can be viewed or downloaded online at [www.gazco.com](http://www.gazco.com)

# Fires for Stovax Classic Fireplaces

Suitable for Class 1 Flue Type

## FIRE INFORMATION

Product Code	Fireplace	Gas Type	Fuel Effect	Heat Input	Heat Output
8000MCUC	Victorian Tiled Insert	Nat. Gas	Coals	10kW	2kW
P8000MCUC	Victorian Tiled Insert	LPG	Coals	10kW	2kW
⊗ 8000MCUCRD	Victorian Tiled Insert (RD)*	Nat. Gas	Coals	7kW	1.4kW
⊗ P8000MCUCRD	Victorian Tiled Insert (RD)*	LPG	Coals	7kW	1.4kW
P8210MCUC	Victorian Tiled Front	Nat Gas	Coals	12kW	2.4kW
P8210MCUC	Victorian Tiled Front	LPG	Coals	12kW	2.4kW
8002MCUC	Horseshoe Insert	Nat Gas	Coals	10kW	2kW
P8002MCUC	Horseshoe Insert	LPG	Coals	10kW	2kW
⊗ 8002MCUCRD	Horseshoe Insert (RD)*	Nat Gas	Coals	7kW	1.4kW
⊗ P8002MCUCRD	Horseshoe Insert (RD)*	LPG	Coals	7kW	1.4kW
8004MCUC	Adelaide Insert	Nat Gas	Coals	10kW	2kW
P8004MCUC	Adelaide Insert	LPG	Coals	10kW	2kW
⊗ 8004MCUCRD	Adelaide Insert (RD)*	Nat Gas	Coals	7kW	1.4kW
⊗ P8004MCUCRD	Adelaide Insert (RD)*	LPG	Coals	7kW	1.4kW
8041MCUC	Regency Hob Grate	Nat Gas	Coals	9kW	1.8kW
P8041MCUC	Regency Hob Grate	LPG	Coals	9kW	1.8kW
8062MCUC	Combination Insert	Nat Gas	Coals	10kW	2kW
⊗ P8062MCUC	Combination Insert	LPG	Coals	10kW	2kW
⊗ 8062MCUCRD	Combination Insert (RD)*	Nat Gas	Coals	7kW	1.4kW
P8062MCUCRD	Combination Insert (RD)*	LPG	Coals	7kW	1.4kW
8064MCUC	Arched Insert	Nat Gas	Coals	10kW	2kW
P8064MCUC	Arched Insert	LPG	Coals	10kW	2kW

Product Code	Fireplace	Gas Type	Fuel Effect	Heat Input	Heat Output
⊗ 8064MCUCRD	Arched Insert (RD)*	Nat Gas	Coals	7kW	1.4kW
⊗ P8064MCUCRD	Arched Insert (RD)*	LPG	Coals	7kW	1.4kW
8102MCUC	Art Nouveau Insert	Nat. Gas	Coals	10kW	2kW
P8102MCUC	Art Nouveau Insert	LPG	Coals	10kW	2kW
⊗ 8102MCUCRD	Art Nouveau Insert (RD)*	Nat Gas	Coals	7kW	1.4kW
⊗ P8102MCUCRD	Art Nouveau Insert (RD)*	LPG	Coals	7kW	1.4kW
8202MCUC	Art Nouveau Tiled Front	Nat Gas	Coals	12kW	2.4kW
P8202MCUC	Art Nouveau Tiled Front	LPG	Coals	12kW	2.4kW
8300UC	Poppy & Wheatsheaf Tiled Front	Nat Gas	Coals	9.45kW	2.35kW
P8300UC	Poppy & Wheatsheaf Tiled Front	LPG	Coals	9.5kW	2.4kW
⊗ 8301UC	Poppy & Wheatsheaf Tiled Front (RD)*	Nat Gas	Coals	6.85kW	1.70kW
⊗ P8301UC	Poppy & Wheatsheaf Tiled Front (RD)*	LPG	Coals	6.65kW	1.65kW
8023MCUC	Knightsbridge/ Kensington Insert	Nat Gas	Coals	16kW	3.2kW
P8023MCUC	Knightsbridge/ Kensington Insert	LPG	Coals	16kW	3.2kW
8023LUC	Knightsbridge/ Kensington Insert	Nat Gas	Logs	16kW	3.2kW
P8023LUC	Knightsbridge/ Kensington Insert	LPG	Logs	16kW	3.2kW

## REMOTE CONTROL OPTION

\*RD - Reduced Draught Fire. Reduced draught models do not require additional room ventilation.

Product Code	Description
8455	Standard remote control kit



# Riva2 500

## RIVA2 500 FIRE INFORMATION

Product Code	Flue Type	Gas Type	Lining	Fuel Type	Heat Input (kW)	Heat Output (kW)	Efficiency	Remote Control	Minimum Opening Size (mm)		
									w	h	d
⊗ 134-070	Class 1 & 2	Nat. Gas	Black Reeded	Logs	6.4kW	4.8kW	75%	Thermostatic	565	560	350
⊗ 134-796	Class 1 & 2	LPG	Black Reeded	Logs	6.4kW	4.8kW	75%	Thermostatic	565	560	350
⊗ 134-118	Class 1 & 2	Nat. Gas	Vermiculite	Logs	6.4kW	4.8kW	75%	Thermostatic	565	560	350
⊗ 134-784	Class 1 & 2	LPG	Vermiculite	Logs	6.4kW	4.8kW	75%	Thermostatic	565	560	350
⊗ 134-147	Class 1 & 2	Nat. Gas	Brick Effect	Logs	6.4kW	4.8kW	75%	Thermostatic	565	560	350
⊗ 134-756	Class 1 & 2	LPG	Brick Effect	Logs	6.4kW	4.8kW	75%	Thermostatic	565	560	350
⊗ 134-275	Balanced flue	Nat. Gas	Black Reeded	Logs	5.8kW	4.8kW	82%	Thermostatic	565	560	350
⊗ 134-447	Balanced flue	LPG	Black Reeded	Logs	5.7kW	4.7kW	82%	Thermostatic	565	560	350
⊗ 134-308	Balanced flue	Nat. Gas	Vermiculite	Logs	5.8kW	4.8kW	82%	Thermostatic	565	560	350
⊗ 134-516	Balanced flue	LPG	Vermiculite	Logs	5.7kW	4.7kW	82%	Thermostatic	565	560	350
⊗ 134-321	Balanced flue	Nat. Gas	Brick Effect	Logs	5.8kW	4.8kW	82%	Thermostatic	565	560	350
⊗ 134-583	Balanced flue	LPG	Brick Effect	Logs	5.7kW	4.7kW	82%	Thermostatic	565	560	350

## RIVA2 500 FRAME INFORMATION

Product Code	Description	Frame Finish	Frame Size (mm)		
			w	h	d
<b>Frame Choice</b>					
934-625	Icon	Black Glass	945	784	30
934-721	Verve XS	Graphite	890	621	57
934-470	Ellingham	Black Cast Iron	885	678	75

## RIVA2 500 OPTIONS

Product Code	Description
934-005	Conventional Flue Black Reeded Lining Set
934-021	Conventional Flue Vermiculite Lining Set
934-030	Conventional Flue Brick Effect Lining Set
934-159	Balanced Flue Black Reeded Lining Set
934-181	Balanced Flue Vermiculite Lining Set
934-203	Balanced Flue Brick Effect Lining Set
8572	Warm Air Ducting Kit (2 outlets) - Balanced Flue Only
999-530	Thermostatic System Mains Adaptor

## RIVA2 500 DIMENSIONS (MM)

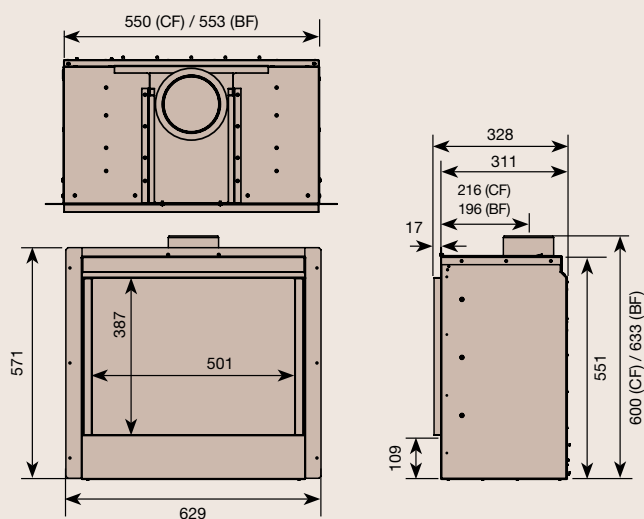

## Coloured Front options for Riva2 500 Verve XS

Please use the product code provided for the Graphite model along with the following suffix for your choice of colour: Metallic Red (RD), Metallic Blue (BL), Metallic Bronze (BZ) and Ivory (IV) - for example: Riva2 500 Verve XS in Ivory = 934-721IV.



Riva2 500 Verve XS in Ivory with Brick Effect Lining



**Metallic Red**  
(Shown with Vermiculite Lining)



**Metallic Bronze**  
(Shown with Brick Effect Lining)



**Metallic Blue**  
(Shown with Black Reeded Lining)

# VFC Fires

## FIRE INFORMATION

Product Code	Description	Flue Type	Gas Type	Fuel Effect	Heat Input (kW)	Heat Output (kW)	Efficiency	Remote Control	Opening Size (mm)			
									w	h	d	
<b>16" VFC Convector Fires</b>												
8420UC	VFC Convector 16"	Class1/PF	Nat. Gas	Coals	9.45	4.75	50%	Upgradable	410	560	310	
P8420UC	VFC Convector 16"	Class1/PF	LPG	Coals	9.50	4.75	50%	Upgradable	410	560	310	
⊗ 8421UC	VFC Convector 16" (RD)	Class1/PF	Nat. Gas	Coals	6.85	3.43	50%	Upgradable	410	560	310	
⊗ P8421UC	VFC Convector 16" (RD)	Class1/PF	LPG	Coals	6.65	3.30	50%	Upgradable	410	560	310	

### 22" VFC Convector Fires

8430UC	VFC Convector 22"	Class1/PF	Nat. Gas	Coals	12.30	6.15	50%	Upgradable	560	560	310
P8430UC	VFC Convector 22"	Class1/PF	LPG	Coals	12.70	6.35	50%	Upgradable	560	560	310

### 16" VFC Tapered Fires

8300UC	VFC Tapered 16"	Class 1	Nat. Gas	Coals	9.45	2.35	25%	Upgradable	See table below		
P8300UC	VFC Tapered 16"	Class 1	LPG	Coals	9.50	2.40	25%	Upgradable	See table below		
⊗ 8301UC	VFC Tapered 16" (RD)	Class 1	Nat. Gas	Coals	6.85	1.70	25%	Upgradable	See table below		
⊗ P8301UC	VFC Tapered 16" (RD)	Class 1	LPG	Coals	6.65	1.65	25%	Upgradable	See table below		

### 22" VFC Tapered Fires

8310UC	VFC Tapered 22"	Class 1	Nat. Gas	Coals	12.30	3.05	25%	Upgradable	See table below		
P8310UC	VFC Tapered 22"	Class 1	LPG	Coals	12.70	3.05	24%	Upgradable	See table below		

RD = Reduced Draught Fire (Input below 7kW does not normally require additional ventilation. Please refer to the installation instructions or discuss with your local Gazco retailer.)

Class 1/PF = Suitable for Class 1 chimneys or a powered flue installation

## VFC DIMENSIONS

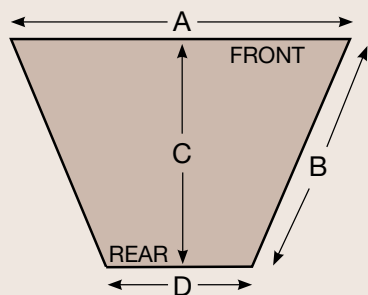

	16"	22"
A	15" 380mm	20 <sup>3</sup> / <sub>4</sub> " 527mm
B	7 <sup>1</sup> / <sub>2</sub> " 190mm	7 <sup>1</sup> / <sub>2</sub> " 190mm
C	7" 180mm	7" 180mm
D	10 <sup>1</sup> / <sub>4</sub> " 260mm	16 <sup>1</sup> / <sub>4</sub> " 414mm

## FRAME AND FRONT INFORMATION

Product Code	Description	Frame Finish	Frame Size (mm)		
			w	h	d
<b>16" VFC Convector Complete Front Choice</b>					
8251GP	Designio front	Graphite	595	615	68
8251IR	Designio front	Iridium	595	615	68
8257BS	Evolution front	Stainless Steel	489	597	45
8253IR	Progress front	Iridium	520	598	60
8678	Richmond front	Black Cast Iron	540	635	50
956-355	Box Profil/Arts Paired	Matt Black	503	604	90
956-519	Box Profil/Arts Paired	Polished Brass-effect	503	604	90
956-083	Box Profil/Arts Paired	Polished Steel-effect	503	604	90
956-616	Box Profil/Arts Paired	Brushed Steel-effect	503	604	90
<b>22" VFC Convector Complete Front Choice</b>					
8252GP	Designio front	Graphite	730	615	68
8252IR	Designio front	Iridium	730	615	68
8259BS	Evolution front	Stainless Steel	639	597	45
8254IR	Progress front	Iridium	670	598	60

## OPTIONS AND ACCESSORIES

Product Code	Description
8455	Standard remote control kit for VFC Convector
8435	Powered Flue kit for VFC coal convector fires, with brass wall switch. **
8435BS	Powered Flue kit for VFC coal convector fires, with brushed steel wall switch **
8448	Rear exit flue adaptor for power flue kit
8449	Top exit flue adaptor for power flue kit
999-159	Safety terminal guard (required if power flue outlet is below 2 metres)

\*\* The powered flue kit includes 500mm flue pipe. Any extra flue pipe needs to be purchased separately, and needs to be of 125mm twin wall construction (not supplied by Gazco).

**Additional Note:** VFC fires require 7" minimum flue size.

# VFC Fires

## FRAME AND FRONT INFORMATION

### VFC Convector and VFC Tapered Fire Front Choice

Description	Frame Finish	Product Code	16" Fires		22" Fires		
			Dimensions (mm)		Product Code	Dimensions (mm)	
			w	h		w	h
Arts fire front	Matt Black	901-425	390	230	N/A	N/A	N/A
Arts fire front	Polished Brass-effect	901-530	390	230	N/A	N/A	N/A
Arts fire front	Polished Chrome-effect	901-476	390	230	N/A	N/A	N/A
Arts fire front	Highlight Polished	901-296	390	230	N/A	N/A	N/A
Holyrood fire front	Matt Black with brass finials	901-012	385	265	901-018	540	265
Holyrood fire front	Polished Brass-effect with black columns	901-042	385	265	901-056	540	265
Holyrood fire front	Highlight Polished	901-102	385	210	901-116	540	210
Holyrood fire front	Polished Chrome-effect	901-147	385	210	901-182	540	210
Spanish fire front	Matt Black	901-008	385	210	8384	540	210
Spanish fire front	Polished Brass-effect	901-085	385	210	901-049	540	210
Spanish fire front	Highlight Polished	901-037	385	210	901-096	540	210
Spanish fire front	Polished Chrome-effect	901-129	385	210	901-157	540	210

### VFC Convector Frame Choice

Description	Frame Finish	Product Code	16" Convector Fires		22" Convector Fires		
			Dimensions (mm)		Product Code	Dimensions (mm)	
			w	h		w	h
Arts frame	Matt Black	8284MB	503	605	N/A	N/A	N/A
Arts frame	Polished Brass	8284PBR	503	605	N/A	N/A	N/A
Arts frame	Polished Stainless Steel	8284P	503	605	N/A	N/A	N/A
Arts frame	Brushed Stainless Steel	8284BS	503	605	N/A	N/A	N/A
Decorative frame #	Matt Black	8285	505	610	8287	655	605
Decorative frame #	Polished Brass	8266	505	610	8268	655	605
Decorative frame #	Polished Stainless Steel	8232	505	610	8234	655	605
Decorative frame #	Brushed Stainless Steel	8235	505	610	8237	655	605
Profil (Standard) frame #	Matt Black	8345	490	600	8365	640	600
Profil (Standard) frame #	Polished Brass	8340	490	600	8360	640	600
Profil (Standard) frame #	Polished Stainless Steel	8342	490	600	8362	640	600
Profil (Standard) frame #	Brushed Stainless Steel	8229	490	600	8231	640	600
Profil (Wide) frame #	Polished Brass	8280	527	615	N/A	N/A	N/A

## ADDITIONAL INFORMATION

You can install a VFC Convector Fire with a Stovax Cast Iron Victorian, Art Nouveau or Combination Fireplace. Please consult your local Gazco and Stovax dealer for further information.

# If you are fitting a Decorative or Profil frame with an Arts Front, an additional fitting kit will be provided to ease installation.

## Fire Baskets

Model	Gas Controls		Overall Dimensions W x H x D in mm			Fuel Options				Gas Heat Outputs (kW)					
	Front	Right side	Small	Medium	Large	Solid fuels	Gas coals	Gas logs	Gas driftwood	Small		Medium		Large	
										In	Out	In	Out	In	Out
Amhurst*†	✓	✓	395 x 330 x 275	520 x 330 x 280	–	✓	✓	✓	✓	12.0	2.4	15.0	3.0	–	–
Art Deco*†	✓	✓	395 x 305 x 280	520 x 305 x 280	–	✓	✓	✓	✓	12.0	2.4	15.0	3.0	–	–
Ascot*	–	✓	735 x 355 x 405	–	–	✓	✓	✓	✓	15.0	3.0	–	–	–	–
Audley*	–	✓	520 x 300 x 280	–	–	✓	✓	✓	✓	15.0	3.0	–	–	–	–
Cheltenham*	–	✓	535 x 485 x 305	–	–	✓	✓	✓	✓	15.0	3.0	–	–	–	–
Cromwell	✓	–	395 x 150 x 250	–	490 x 150 x 275	✓	✓	✓	✓	12.0	2.4	–	–	15.0	3.0
Halifax*	–	✓	520 x 455 x 280	–	–	✓	✓	✓	✓	15.0	3.0	–	–	–	–
Harlech*	–	✓	520 x 485 x 280	–	–	✓	✓	✓	✓	15.0	3.0	–	–	–	–
Kendal*	–	✓	900 x 660 x 430	–	–	✓	✓	✓	✓	15.0	3.0	–	–	–	–
Ludlow*	–	✓	560 x 645 x 280	–	–	✓	✓	✓	✓	15.0	3.0	–	–	–	–
Melbury*	–	✓	740 x 645 x 405	–	–	✓	✓	✓	✓	15.0	3.0	–	–	–	–
Milan †	✓	✓	601 x 305 x 378	727 x 305 x 378	–	✓	✓	✓	✓	12.0	2.4	15.0	3.0	–	–
Montrose*	–	✓	740 x 580 x 405	–	–	✓	✓	✓	✓	15.0	3.0	–	–	–	–
Portland*	–	✓	520 x 305 x 280	–	–	✓	✓	✓	✓	15.0	3.0	–	–	–	–
Portland Extended*	–	✓	735 x 305 x 308	–	–	✓	✓	✓	✓	15.0	3.0	–	–	–	–
Rochester*	✓	✓	520 x 415 x 280	–	–	✓	✓	✓	✓	15.0	3.0	–	–	–	–
Spanish	✓	–	447 x 235 x 318	–	525 x 235 x 369	✓	✓	✓	✓	13.0	2.6	–	–	15.0	3.0
Stratford*	✓	✓	520 x 330 x 280	–	–	✓	✓	✓	✓	15.0	3.0	–	–	–	–

\* Allow 150mm between basket and fireplace opening to reach right hand side controls.

† Please note the Small Amhurst, Small Art Deco and Small Milan can be supplied as reduced draft versions where the input is under 7kW. This means that no air vent will be required.



# Important Information



## Technical Specifications

All specifications given in this brochure are approximate. Actual specifications for each individual product will vary according to model. Your Gazco retailer will be pleased to provide any further information you require or you may view/download specification sheets from [www.gazco.com](http://www.gazco.com)

## Installation and Safety

Gazco gas fires must be fitted by a qualified gas installer (GasSafe registered in the United Kingdom or Bord Gáis registered in the Republic of Ireland) who should also verify the proposed site conditions are fully suitable for the product selected. Complete installation instructions for many models can be obtained prior to purchase by viewing or downloading them from [www.gazco.com](http://www.gazco.com)

Please note that all parts of these fires, particularly the glass panel on certain models, become extremely hot during operation and can result in serious injury and burns if touched. It is therefore recommended that a fireguard complying with BS 8423:2002 is used in the presence of young children, the elderly or infirm.

## Colours/Flame pictures

Owing to variations in studio lighting and printing inks, the finishes/colours of fires illustrated in this brochure may differ slightly from actual models. Before purchasing, please ask your retailer to show you finish/colour samples. Whilst all the flame pictures shown in this brochure are actual fires, flame pictures may vary depending on the installation, flue conditions and geographical/surrounding features that may effect the efficiency of the flue.

## Care and maintenance

Traditional materials, such as polished steel and brass, tarnish on contact with air, especially when also exposed to heat. To help minimise this effect, we recommend fires receive regular treatment with suitable proprietary cleaners. Additionally, please remember that gas fires will require servicing annually by a qualified gas installer (GasSafe registered in the United Kingdom or Bord Gáis registered in the Republic of Ireland).

## Warranty and product improvement



Your Gazco Expert Retailer will provide you with a five Year Warranty for your new gas fire, provided your fire is registered with Gazco. The second and subsequent years are dependant on the appliance being serviced 12 months after installation and annually thereafter and excludes certain consumable parts. Full details of this warranty are available at [www.gazco.com](http://www.gazco.com).

Gazco pursue a policy of continuous product improvement, therefore, whilst our products are correct at the time of the photography, we reserve the right to make alterations and amendments. Exact product details should be discussed with your retailer at the time of purchase.

## Air ventilation for gas fires

To comply with gas appliance installation regulations, all Standard VFC Convector and tapered fires require additional ventilation into your room. Please consult either your Gazco retailer or the Gazco Technical Information on our website [www.gazco.com](http://www.gazco.com) to confirm the ventilation required. Gazco offer suitable wall and floor vents which are available from your local retailer. All other fires featured in this brochure do not normally require additional ventilation.



**Wall Vent** -  
One size;  
choice of brass  
or stainless steel



**Floor Vent** -  
Two sizes,  
brass only

# Also available from the Gazco family...



## Gazco Gas Fires

[www.gazco.com](http://www.gazco.com)

Whether you want to create an up-to-the minute contemporary look, a more traditional style or the ultimate wow factor with our large format fires, we have hundreds of different fire and fire surround permutations for you to choose from. To receive a copy of the latest Gazco Fires brochure please call 0844 4141 322.



## Gazco Electric Fires & Stoves

[www.gazco.com](http://www.gazco.com)

It's never been so easy to get the warm inviting atmosphere of a real flame fire with all the convenience, versatility and efficiency of electric. Using the latest Flame-Effect Technology, Gazco has created a beautiful range of electric fires & stoves that provide a versatile & stunning focal point for any home – and all without the need for a chimney! To receive a copy of the Gazco Electric Fires & Stoves brochure, please call 0844 4141 322.



## Classic Fireplaces

[www.stovax.com](http://www.stovax.com)

Inspired by 19th Century designs and hand-cast to the same specification as Victorian and Georgian originals, Stovax Classic Fireplaces allows you to create the authentic look of a period fireplace but with the flexibility required for modern-day living. These fireplaces are available as solid fuel or gas fires. To receive a copy of the latest Classic Fireplaces brochure please call 0844 4141 322.



## Fireplace Surround Packages

[www.stovax.com](http://www.stovax.com)

Complement and enhance your new fire with a stylish and unique fireplace surround that will make your interior a design statement even when the fire is not lit. This stunning collection of 35 porcelain and natural stone tiles have been hand-picked to complement many Stovax and Gazco fireplaces, so you can create your ultimate look. Please visit [www.stovax.com](http://www.stovax.com) to download the latest Fireplace Surround Packages brochure.

To view the full range of brochures available, please visit [www.gazco.com](http://www.gazco.com) or scan the QR Code with your mobile device. Gazco is a member of the Stovax Group.



Gazco gratefully acknowledges the assistance of the following companies with photographic settings:

Furnishings and Ornaments:- [www.furniturevillage.co.uk](http://www.furniturevillage.co.uk); [www.lauraashley.com](http://www.lauraashley.com); [www.faginsantiques.com](http://www.faginsantiques.com); [www.theorangetree.co.uk](http://www.theorangetree.co.uk);  
[www.houseoffraser.co.uk](http://www.houseoffraser.co.uk); [www.ashorejewellery.co.uk](http://www.ashorejewellery.co.uk); [www.electique.co.uk](http://www.electique.co.uk); [www.debenhams.com](http://www.debenhams.com); Pilgrim Antiques, Honiton

Wood Mantels:- [www.stovax.com](http://www.stovax.com) Stone Mantels:- [www.farmington.co.uk](http://www.farmington.co.uk); [www.bnsp.co.uk](http://www.bnsp.co.uk); [www.grandisson.com](http://www.grandisson.com); [www.rudloe-stone.com](http://www.rudloe-stone.com)

Tiles & Stone Floors:- [www.originalstyle.com](http://www.originalstyle.com) Lighting:- [www.amoslighting.co.uk](http://www.amoslighting.co.uk) Flowers:- [www.piccalilly.co.uk](http://www.piccalilly.co.uk)







Logic HE fire, white stone fuel bed with **Designio2 Glass** complete front with Slide control.

To view & download our complete range of brochures, simply scan this code or visit [www.gazco.com](http://www.gazco.com)



### Gazco Limited

Osprey Road, Sowton Industrial Estate, Exeter, Devon, England EX2 7JG

Tel: 01392 261999 Fax: 01392 444148

E-mail: [info@gazco.com](mailto:info@gazco.com) [www.gazco.com](http://www.gazco.com)

*A member of the Stovax Group*

Your Gazco stockist:

£3.00

